

# Certificate of Conformity

Certificate Number: CN-PV-220113

On the basis of the tests undertaken, the samples of the below product have been found to comply with the requirements of the referenced specifications /standards at the time the tests were carried out. It does not imply that Intertek has performed any surveillance or control of the manufacture. The manufacturer shall ensure that the manufacturing process assures compliance of the production units with the examined products mentioned in this certificate.

|   |   |
|---|---|
| <b>Applicant:</b>                                     | Shenzhen Growatt New Energy Co., Ltd.<br>4-13/F, Building A, Sino-German (Europe) Industrial Park, Hangcheng Ave, Bao'an District, Shenzhen, China  |
| <b>Product:</b>                                       | PV Grid inverter  |
| <b>Ratings &amp; Principle Characteristics:</b>       | See Appendix to Certificate of Conformity   |
| <b>Model:</b>   | MAX 50KTL3-XL2, MAX 60KTL3-XL2, MAX 70KTL3-XL2, MAX 73KTL3-XL2<br>MAX 75KTL3-XL2, MAX 50KTL3-XL1, MAX 60KTL3-XL1, MAX 70KTL3-XL1,<br>MAX 73KTL3-XL1, MAX 75KTL3-XL1   |
| <b>Brand Name&lt;s&gt;:</b>                           | GROWATT   |
| <b>Product Complies with:</b>                         | IEC 61727:2004. Photovoltaic (PV) systems – Characteristics of the utility interface<br>IEC 62116:2014. Test procedure of islanding prevention measures for utility-interconnected photovoltaic inverters   |
| <b>Certificate Issuing Office Name &amp; Address:</b> | Intertek Testing Services Ltd. Shanghai<br>West Area, 2nd Floor, No. 707, Zhangyang Road<br>China (Shanghai) Pilot Free Trade Zone, Shanghai, P. R. China<br><br>Accredited by China National Accreditation Service for Conformity Assessment (CNAS C058-P) in accordance with ISO/IEC 17065:2012 |
| <b>Test Report No.&lt;s&gt;:</b>                      | 220308046GZU-001, 220308046GZU-002  |

Certification procedure: SMS-PV-OP-19  
Product certification scheme type: Type test  
Additional information in Appendix.



Signature

Certification Manager: Grady Ye

Date: 1 June 2022



中国认可  
国际互认  
产品  
PRODUCT  
CNAS C058-P

## APPENDIX: Certificate of Conformity

This is an Appendix to Certificate of Conformity Number: CN-PV-220113

| Model                         | MAX 50KTL3-<br>XL2    | MAX 60KTL3-<br>XL2 | MAX 70KTL3-<br>XL2 | MAX 73KTL3-<br>XL2 | MAX 75KTL3-<br>XL2 |
|-------------------------------|-----------------------|--------------------|--------------------|--------------------|--------------------|
| Max.PV voltage                | 1100Vdc               |                    |                    |                    |                    |
| MPPT voltage                  | 180-850Vdc            |                    |                    |                    |                    |
| Max.input current             | 8*45A                 |                    |                    |                    |                    |
| PV Isc                        | 8*56.5A               |                    |                    |                    |                    |
| Nominal output voltage        | 3W/N/PE, 127/220Vac   |                    |                    |                    |                    |
| Nominal output Frequency      | 50/60Hz               |                    |                    |                    |                    |
| Max.output current            | 144.3A                | 173.2A             | 183.7A             | 191.6A             | 196.9A             |
| Max. output power             | 50KW                  | 60KW               | 70KW               | 73KW               | 75KW               |
| Max. apparent power           | 55KVA                 | 66KVA              | 70KVA              | 73KVA              | 75KVA              |
| Power factor range            | 0.8Leading~0.8Lagging |                    |                    |                    |                    |
| Safety level                  | Class I               |                    |                    |                    |                    |
| Ingress Protection            | IP 66                 |                    |                    |                    |                    |
| Operation Ambient Temperature | -30°C - +60°C         |                    |                    |                    |                    |
| Software version              | TN1.0                 |                    |                    |                    |                    |

This Certificate is for the exclusive use of Intertek's client and is provided pursuant to the agreement between Intertek and its Client. Intertek's responsibility and liability are limited to the terms and conditions of the agreement. Intertek assumes no liability to any party, other than to the Client in accordance with the agreement, for any loss, expense or damage occasioned by the use of this Certificate. Only the Client is authorized to permit copying or distribution of this Certificate. Any use of the Intertek name or one of its marks for the sale or advertisement of the tested material, product or service must first be approved in writing by Intertek.

## APPENDIX: Certificate of Conformity

This is an Appendix to Certificate of Conformity Number: CN-PV-220113

| Model                         | MAX 50KTL3-<br>XL1    | MAX 60KTL3-<br>XL1 | MAX 70KTL3-<br>XL1 | MAX 73KTL3-<br>XL1 | MAX 75KTL3-<br>XL1 |
|-------------------------------|-----------------------|--------------------|--------------------|--------------------|--------------------|
| Max.PV voltage                | 1100Vdc               |                    |                    |                    |                    |
| MPPT voltage                  | 180-850Vdc            |                    |                    |                    |                    |
| Max.input current             | 10*32A                |                    |                    |                    |                    |
| PV Isc                        | 10*40A                |                    |                    |                    |                    |
| Nominal output voltage        | 3W/N/PE, 127/220Vac   |                    |                    |                    |                    |
| Nominal output Frequency      | 50/60Hz               |                    |                    |                    |                    |
| Max.output current            | 144.3A                | 173.2A             | 183.7A             | 191.6A             | 196.9A             |
| Max. output power             | 50KW                  | 60KW               | 70KW               | 73KW               | 75KW               |
| Max. apparent power           | 55KVA                 | 66KVA              | 70KVA              | 73KVA              | 75KVA              |
| Power factor range            | 0.8Leading~0.8Lagging |                    |                    |                    |                    |
| Safety level                  | Class I               |                    |                    |                    |                    |
| Ingress Protection            | IP 66                 |                    |                    |                    |                    |
| Operation Ambient Temperature | -30°C - +60°C         |                    |                    |                    |                    |
| Software version              | TN1.0                 |                    |                    |                    |                    |

This Certificate is for the exclusive use of Intertek's client and is provided pursuant to the agreement between Intertek and its Client. Intertek's responsibility and liability are limited to the terms and conditions of the agreement. Intertek assumes no liability to any party, other than to the Client in accordance with the agreement, for any loss, expense or damage occasioned by the use of this Certificate. Only the Client is authorized to permit copying or distribution of this Certificate. Any use of the Intertek name or one of its marks for the sale or advertisement of the tested material, product or service must first be approved in writing by Intertek.



TL-395

Test Report issued under the responsibility of:



TEST REPORT
IEC 61727
Photovoltaic (PV) systems –
Characteristics of the utility interface

Report Number..... : 220308046GZU-001
Date of issue..... : 30 May 2022
Total number of pages ..... 26 Pages

Name of Testing Laboratory preparing the Report ..... Intertek Testing Services Shenzhen Ltd. Guangzhou Branch
Room 02, & 101/E201/E301/E401/E501/E601/E701/E801 of
Room 01 1-8/F., No. 7-2. Caipin Road, Science City, GETDD,
Guangzhou, Guangdong, China

Applicant's name ..... Shenzhen Growatt New Energy Co., Ltd.
Address..... 4-13/F, Building A, Sino-German (Europe) Industrial Park,
Hangcheng Ave, Bao'an District, Shenzhen, China

Test specification:
Standard ..... : IEC 61727:2004
Test procedure ..... : Type approval
Non-standard test method ..... : N/A

Test Report Form No. .... : IEC61727B
Test Report Form(s) Originator .... : TÜV SÜD Product Service GmbH
Master TRF ..... : Dated 2017-11-03

Copyright © 2017 IEC System of Conformity Assessment Schemes for Electrotechnical
Equipment and Components (IECEE System). All rights reserved.

This publication may be reproduced in whole or in part for non-commercial purposes as long as the IECEE is acknowledged as
copyright owner and source of the material. IECEE takes no responsibility for and will not assume liability for damages resulting
from the reader's interpretation of the reproduced material due to its placement and context.

If this Test Report Form is used by non-IECEE members, the IECEE/IEC logo and the reference to the
CB Scheme procedure shall be removed.

This report is not valid as a CB Test Report unless signed by an approved CB Testing Laboratory
and appended to a CB Test Certificate issued by an NCB in accordance with IECEE 02.

General disclaimer:

The test results presented in this report relate only to the object tested.
This report shall not be reproduced, except in full, without the written approval of the Issuing CB Testing
Laboratory. The authenticity of this Test Report and its contents can be verified by contacting the NCB,
responsible for this Test Report.

|                                |   |                       |                       |                       |                       |                       |
|--------------------------------|---|-----------------------|-----------------------|-----------------------|-----------------------|-----------------------|
| <b>Test item description :</b> | PV Grid inverter  |                       |                       |                       |                       |                       |
| <b>Trade Mark .....</b>        | GROWATT   |                       |                       |                       |                       |                       |
| <b>Manufacturer.....</b>       | Same as applicant   |                       |                       |                       |                       |                       |
| <b>Model/Type reference :</b>  | MAX 50KTL3-XL2, MAX 60KTL3-XL2, MAX 70KTL3-XL2, MAX 73KTL3-XL2<br>MAX 75KTL3-XL2, MAX 50KTL3-XL1, MAX 60KTL3-XL1, MAX 70KTL3-XL1,<br>MAX 73KTL3-XL1, MAX 75KTL3-XL1 |                       |                       |                       |                       |                       |
| <b>Ratings .....</b>           | Model   | MAX<br>50KTL3-<br>XL2 | MAX<br>60KTL3-<br>XL2 | MAX<br>70KTL3-<br>XL2 | MAX<br>73KTL3-<br>XL2 | MAX<br>75KTL3-<br>XL2 |
|                                | Max.PV<br>voltage   | 1100Vdc               |                       |                       |                       |                       |
|                                | MPPT<br>voltage   | 180-850Vdc            |                       |                       |                       |                       |
|                                | Max.input<br>current  | 8*45A                 |                       |                       |                       |                       |
|                                | PV Isc  | 8*56.5A               |                       |                       |                       |                       |
|                                | Nominal<br>output<br>voltage  | 3W/N/PE, 127/220Vac   |                       |                       |                       |                       |
|                                | Nominal<br>output<br>Frequency  | 50/60Hz               |                       |                       |                       |                       |
|                                | Max.output<br>current   | 144.3A                | 173.2A                | 183.7A                | 191.6A                | 196.9A                |
|                                | Max. output<br>power  | 50KW                  | 60KW                  | 70KW                  | 73KW                  | 75KW                  |
|                                | Max.<br>apparent<br>power   | 55KVA                 | 66KVA                 | 70KVA                 | 73KVA                 | 75KVA                 |
|                                | Power factor<br>range   | 0.8Leading~0.8Lagging |                       |                       |                       |                       |
|                                | Safety level  | Class I               |                       |                       |                       |                       |
|                                | Ingress<br>Protection   | IP 66                 |                       |                       |                       |                       |
|                                | Operation<br>Ambient<br>Temperature   | -30°C - +60°C         |                       |                       |                       |                       |
|                                | Software<br>version   | TN1.0                 |                       |                       |                       |                       |
|                                | Model   | MAX<br>50KTL3-<br>XL1 | MAX<br>60KTL3-<br>XL1 | MAX<br>70KTL3-<br>XL1 | MAX<br>73KTL3-<br>XL1 | MAX<br>75KTL3-<br>XL1 |



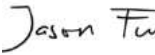

|                               |                       |        |        |        |        |
|-------------------------------|-----------------------|--------|--------|--------|--------|
| Max.PV voltage                | 1100Vdc               |        |        |        |        |
| MPPT voltage                  | 180-850Vdc            |        |        |        |        |
| Max.input current             | 10*32A                |        |        |        |        |
| PV Isc                        | 10*40A                |        |        |        |        |
| Nominal output voltage        | 3W/N/PE, 127/220Vac   |        |        |        |        |
| Nominal output Frequency      | 50/60Hz               |        |        |        |        |
| Max.output current            | 144.3A                | 173.2A | 183.7A | 191.6A | 196.9A |
| Max. output power             | 50KW                  | 60KW   | 70KW   | 73KW   | 75KW   |
| Max. apparent power           | 55KVA                 | 66KVA  | 70KVA  | 73KVA  | 75KVA  |
| Power factor range            | 0.8Leading~0.8Lagging |        |        |        |        |
| Safety level                  | Class I               |        |        |        |        |
| Ingress Protection            | IP 66                 |        |        |        |        |
| Operation Ambient Temperature | -30°C - +60°C         |        |        |        |        |
| Software version              | TN1.0                 |        |        |        |        |

|   |   |   |
|---|---|---|
| <b>Responsible Testing Laboratory (as applicable), testing procedure and testing location(s):</b> |   |   |
| <input checked="" type="checkbox"/>   | <b>Testing Laboratory:</b>                          | Intertek Testing Services Shenzhen Ltd. Guangzhou Branch  |
| <b>Testing location/ address.....:</b>  |   | Room 02, & 101/E201/E301/E401/E501/E601/E701/E801 of Room 01 1-8/F., No. 7-2. Caipin Road, Science City, GETDD, Guangzhou, Guangdong, China |
| <input type="checkbox"/>  | <b>Associated CB Testing Laboratory:</b>            | N/A   |
| <b>Testing location/ address.....:</b>  |   | N/A   |
| <b>Tested by (name, function, signature).....:</b>  |   | Joss Huang<br>Engineer<br>                               |
| <b>Approved by (name, function, signature)....:</b>   |   | Jason Fu<br>Supervisor<br>                               |
| <hr/>   |   |   |
| <input type="checkbox"/>  | <b>Testing procedure: TMP/CTF Stage 1:</b>          | N/A   |
| <b>Testing location/ address.....:</b>  |   | N/A   |
| <b>Tested by (name, function, signature).....:</b>  |   | N/A   |
| <b>Approved by (name, function, signature)....:</b>   |   | N/A   |
| <hr/>   |   |   |
| <input type="checkbox"/>  | <b>Testing procedure: WMT/CTF Stage 2:</b>          | N/A   |
| <b>Testing location/ address.....:</b>  |   | N/A   |
| <b>Tested by (name + signature) .....</b>   |   | N/A   |
| <b>Witnessed by (name, function, signature) .:</b>  |   | N/A   |
| <b>Approved by (name, function, signature)....:</b>   |   | N/A   |
| <hr/>   |   |   |
| <input type="checkbox"/>  | <b>Testing procedure:<br/>SMT/CTF Stage 3 or 4:</b> | N/A   |
| <b>Testing location/ address.....:</b>  |   | N/A   |
| <b>Tested by (name, function, signature).....:</b>  |   | N/A   |
| <b>Witnessed by (name, function, signature) .:</b>  |   | N/A   |
| <b>Approved by (name, function, signature)....:</b>   |   | N/A   |
| <b>Supervised by (name, function, signature) :</b>  |   | N/A   |

|   |   |
|---|---|
| <b>List of Attachments (including a total number of pages in each attachment):</b><br><b>Appendix 1: photos (3 pages)</b> |   |
| <b>Summary of testing:</b>  |   |
| <b>Tests performed (name of test and test clause):</b><br>All applicable tests  | <b>Testing location:</b><br>Intertek Testing Services Shenzhen Ltd.<br>Guangzhou Branch<br>Room 02, &<br>101/E201/E301/E401/E501/E601/E701/E801 of<br>Room 01 1-8/F., No. 7-2. Caipin Road, Science<br>City, GETDD, Guangzhou, Guangdong, China |
| <b>Summary of compliance with National Differences:</b><br><b>List of countries addressed</b><br>N/A                      |   |
| <input checked="" type="checkbox"/> <b>The product fulfils the requirements of IEC 61727:2004</b>                         |   |

**Copy of marking plate:**

The artwork below may be only a draft. The use of certification marks on a product must be authorized by the respective NCBs that own these marks.

| <br>PV Grid Inverter            |                          | <br>PV Grid Inverter           |                          |
|--|--------------------------|---|--------------------------|
| Model name   | MAX 75KTL3-XL1           | Model name  | MAX 75KTL3-XL2           |
| Max. PV voltage  | 1100 d.c.V               | Max. PV voltage   | 1100 d.c.V               |
| PV voltage range   | 180-850 d.c.V            | PV voltage range  | 180-850 d.c.V            |
| PV Isc   | 32 d.c.A*10              | PV Isc  | 56.5 d.c.A*8             |
| Max. input current   | 40 d.c.A*10              | Max. input current  | 45 d.c.A*8               |
| Max. output power  | 75 kW                    | Max. output power   | 75 kW                    |
| Max. apparent power  | 75 kVA                   | Max. apparent power   | 75 kVA                   |
| Nominal output voltage   | 3W/N/PE<br>127/220 a.c.V | Nominal output voltage  | 3W/N/PE<br>127/220 a.c.V |
| Max. output current  | 196.9 a.c.A              | Max. output current   | 196.9 a.c.A              |
| Nominal output frequency   | 50/60 Hz                 | Nominal output frequency  | 50/60 Hz                 |
| Power factor range   | 0.8leading~0.8lagging    | Power factor range  | 0.8leading~0.8lagging    |
| Safety level   | Class I                  | Safety level  | Class I                  |
| Ingress protection   | IP66                     | Ingress protection  | IP66                     |
| Operation ambient temperature  | -30°C ~ +60°C            | Operation ambient temperature   | -30°C ~ +60°C            |
| VDE0126-1-1<br> Made in China |                          | VDE0126-1-1<br> Made in China |                          |

**Note:**

1. The above markings are the minimum requirements required by the safety standard. For the final production samples, the additional markings which do not give rise to misunderstanding may be added.
2. Label is attached on the side surface of enclosure and visible after installation.
3. Other labels are identical to above, except the model's name and ratings

|  |  |
|--|--|
| <b>Test item particulars</b> .....:  |  |
| <b>Classification of installation and use</b> .....: Fixed and outdoor use   |  |
| <b>Supply Connection</b> .....: Permanent connection   |  |
| .....:   |  |
| <b>Possible test case verdicts:</b>  |  |
| - test case does not apply to the test object..... : N/A   |  |
| - test object does meet the requirement..... : P (Pass)  |  |
| - test object does not meet the requirement..... : F (Fail)  |  |
| <b>Testing</b> ..... :   |  |
| <b>Date of receipt of test item</b> ..... : 06 April 2022  |  |
| <b>Date (s) of performance of tests</b> ..... : 06 April 2022 to 10 May 2022   |  |
| <b>General remarks:</b>  |  |
| <p>"(See Enclosure #)" refers to additional information appended to the report.<br/>         "(See appended table)" refers to a table appended to the report.<br/> <b>Throughout this report a <input type="checkbox"/> comma / <input checked="" type="checkbox"/> point is used as the decimal separator.</b><br/>         Determination of the test conclusion is based on IEC Guide 115 in consideration of measurement uncertainty.<br/>         This report is for the exclusive use of Intertek's Client and is provided pursuant to the agreement between Intertek and its Client. Intertek's responsibility and liability are limited to the terms and conditions of the agreement. Intertek assumes no liability to any party, other than to the Client in accordance with the agreement, for any loss, expense or damage occasioned by the use of this report. Only the Client is authorized to permit copying or distribution of this report and then only in its entirety. Any use of the Intertek name or one of its marks for the sale or advertisement of the tested material, product or service must first be approved in writing by Intertek. The observations and test results in this report are relevant only to the sample tested. This report by itself does not imply that the material, product, or service is or has ever been under an Intertek certification program.<br/>         The test report only allows to be revised only within the report defined retention period unless standard or regulation was withdrawn or invalid.<br/> <b>This report shall be used together with the report 220308046GZU-002.</b></p> |  |
| <b>Manufacturer's Declaration per sub-clause 4.2.5 of IEC 61272:</b>   |  |
| The application for obtaining a CB Test Certificate includes more than one factory location and a declaration from the Manufacturer stating that the sample(s) submitted for evaluation is (are) representative of the products from each factory has been provided ..... :  | <input type="checkbox"/> <b>Yes</b><br><input checked="" type="checkbox"/> <b>Not applicable</b> |
| <b>When differences exist; they shall be identified in the General product information section.</b>  |  |
| <b>Name and address of factory (ies)</b> ..... : Guangdong Growatt New Energy Co., Ltd.<br>Growatt Industrial Park, No.17 Pingheng Road<br>Pingtan Town, Huiyang District, Huizhou, Guangdong, China   |  |

**General product information:**

The unit is a three-phase PV Grid inverter, it can convert the high PV voltage to Grid voltage and feed into Grid network.

The unit is providing EMC filtering at the PV side and AC side. It is transformerless between the PV circuit and AC circuit.

The unit has three controllers. The master controller DSP A measure the PV voltage and current, AFCI, PV ISO and also communicate with the slave controller B and slave controller ARM and etc; The slave controller DSP B is used to INV control and PV ISO measurement and etc.

The slave controller ARM monitor AC voltage, GFCI and communicate with the master controller DSP

The relays are designed to redundant structure that controlled by separately.

The master controller A and slave controller B are used together to control relay open or close, if the single fault on one controller, the other controller can be capable to open the relay, so that still providing safety means.

The topology diagram as following:

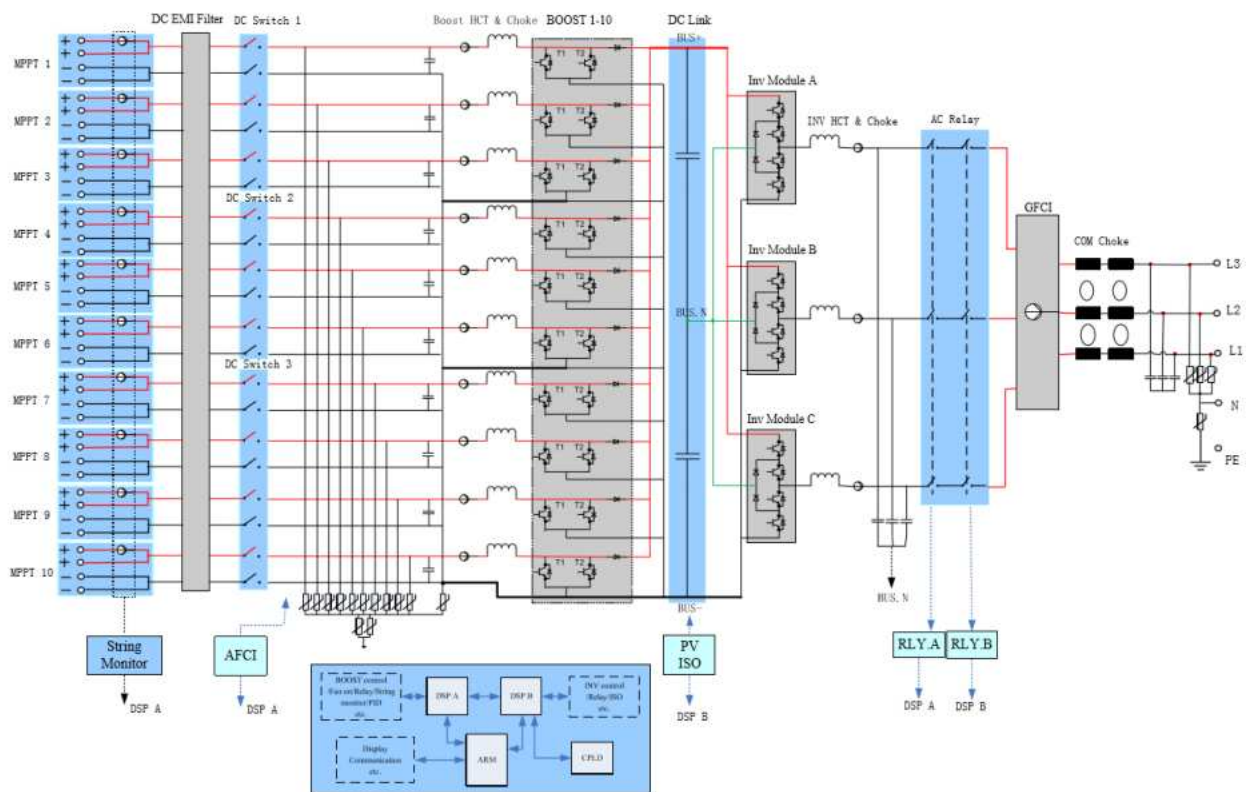

**Difference of models:**

All models are identical, except the number of MPPT and the output power derating in software.

Other than special notice, the model MAX 75KTL3-XL2 is as the representative test model in this report.

| IEC61727   |  |                      |          |
|------------|--|----------------------|----------|
| Cl.        | Requirement - Test   | Result               | Verdict  |
| <b>4</b>   | <b>UTILITY COMPATIBILITY</b>   |                      | <b>P</b> |
|            | The quality of power provided by the PV system for the on-site AC loads and for power delivered to the utility is governed by practices and standards on voltage, flicker, frequency, harmonics and power factor.  |                      | P        |
|            | Deviation from these standards represents out-of-bounds conditions and may require the PV system to sense the deviation and properly disconnect from the utility system.   |                      | P        |
| <b>4.1</b> | <b>Voltage, current and frequency</b>  |                      | <b>P</b> |
|            | The PV system AC voltage, current and frequency are compatible with the utility system.  |                      | P        |
| <b>4.2</b> | <b>Normal voltage operating range</b>  |                      | <b>P</b> |
|            | Utility-interconnected PV systems do not normally regulate voltage, they inject current into the utility. Therefore, the voltage operating range for PV inverters is selected as a protection function that responds to abnormal utility conditions, not as a voltage regulation function. |                      | P        |
| <b>4.3</b> | <b>Flicker</b>   |                      | <b>P</b> |
|            | The operation of the PV system is not cause voltage flicker in excess of limits stated in the relevant sections of IEC 61000-3-3 for systems less than 16 A or IEC 61000-3-5 for systems with current of 16 A and above.   |                      | P        |
| <b>4.4</b> | <b>DC injection</b>  |                      | <b>P</b> |
|            | The PV system is not inject DC current greater than 1 % of the rated inverter output current, into the utility AC interface under any operating condition.   | (See appended table) | P        |
| <b>4.5</b> | <b>Normal frequency operating range</b>  |                      | <b>P</b> |
|            | The PV system operates in synchronism with the utility system, and within the frequency trip limits defined in 5.2.2.  |                      | P        |
| <b>4.6</b> | <b>Harmonics and waveform distortion</b>   |                      | <b>P</b> |
|            | Total harmonic current distortion is less than 5 % at rated inverter output. Each individual harmonic is limited to the percentages listed in Table 1.   | (See appended table) | P        |
|            | Even harmonics in these ranges is less than 25 % of the lower odd harmonic limits listed.  |                      | P        |

| IEC61727                                  |  |  |          |               |                  |   |                 |   |                 |   |                 |   |                 |                |                  |   |                 |   |                 |  |   |
|---|--|--|----------|---------------|------------------|---|-----------------|---|-----------------|---|-----------------|---|-----------------|----------------|------------------|---|-----------------|---|-----------------|--|---|
| Cl.                                       | Requirement - Test   | Result   | Verdict  |               |                  |   |                 |   |                 |   |                 |   |                 |                |                  |   |                 |   |                 |  |   |
|   | <table border="1"> <thead> <tr> <th colspan="2">Table 1 – Current distortion limits</th> </tr> <tr> <th>Odd harmonics</th> <th>Distortion limit</th> </tr> </thead> <tbody> <tr> <td>3<sup>rd</sup> through 9<sup>th</sup></td> <td>Less than 4,0 %</td> </tr> <tr> <td>11<sup>th</sup> through 15<sup>th</sup></td> <td>Less than 2,0 %</td> </tr> <tr> <td>17<sup>th</sup> through 21<sup>st</sup></td> <td>Less than 1,5 %</td> </tr> <tr> <td>23<sup>rd</sup> through 33<sup>rd</sup></td> <td>Less than 0,6 %</td> </tr> <tr> <th>Even harmonics</th> <th>Distortion limit</th> </tr> <tr> <td>2<sup>nd</sup> through 8<sup>th</sup></td> <td>Less than 1,0 %</td> </tr> <tr> <td>10<sup>th</sup> through 32<sup>nd</sup></td> <td>Less than 0,5 %</td> </tr> </tbody> </table> | Table 1 – Current distortion limits                            |          | Odd harmonics | Distortion limit | 3 <sup>rd</sup> through 9 <sup>th</sup> | Less than 4,0 % | 11 <sup>th</sup> through 15 <sup>th</sup> | Less than 2,0 % | 17 <sup>th</sup> through 21 <sup>st</sup> | Less than 1,5 % | 23 <sup>rd</sup> through 33 <sup>rd</sup> | Less than 0,6 % | Even harmonics | Distortion limit | 2 <sup>nd</sup> through 8 <sup>th</sup> | Less than 1,0 % | 10 <sup>th</sup> through 32 <sup>nd</sup> | Less than 0,5 % |  | P |
| Table 1 – Current distortion limits       |  |  |          |               |                  |   |                 |   |                 |   |                 |   |                 |                |                  |   |                 |   |                 |  |   |
| Odd harmonics                             | Distortion limit   |  |          |               |                  |   |                 |   |                 |   |                 |   |                 |                |                  |   |                 |   |                 |  |   |
| 3 <sup>rd</sup> through 9 <sup>th</sup>   | Less than 4,0 %  |  |          |               |                  |   |                 |   |                 |   |                 |   |                 |                |                  |   |                 |   |                 |  |   |
| 11 <sup>th</sup> through 15 <sup>th</sup> | Less than 2,0 %  |  |          |               |                  |   |                 |   |                 |   |                 |   |                 |                |                  |   |                 |   |                 |  |   |
| 17 <sup>th</sup> through 21 <sup>st</sup> | Less than 1,5 %  |  |          |               |                  |   |                 |   |                 |   |                 |   |                 |                |                  |   |                 |   |                 |  |   |
| 23 <sup>rd</sup> through 33 <sup>rd</sup> | Less than 0,6 %  |  |          |               |                  |   |                 |   |                 |   |                 |   |                 |                |                  |   |                 |   |                 |  |   |
| Even harmonics                            | Distortion limit   |  |          |               |                  |   |                 |   |                 |   |                 |   |                 |                |                  |   |                 |   |                 |  |   |
| 2 <sup>nd</sup> through 8 <sup>th</sup>   | Less than 1,0 %  |  |          |               |                  |   |                 |   |                 |   |                 |   |                 |                |                  |   |                 |   |                 |  |   |
| 10 <sup>th</sup> through 32 <sup>nd</sup> | Less than 0,5 %  |  |          |               |                  |   |                 |   |                 |   |                 |   |                 |                |                  |   |                 |   |                 |  |   |
| 4.7                                       | The PV system has a lagging power factor greater than 0,9 when the output is greater than 50 % of the rated inverter output power.   |  | P        |               |                  |   |                 |   |                 |   |                 |   |                 |                |                  |   |                 |   |                 |  |   |
| <b>5</b>                                  | <b>PERSONNEL SAFETY AND EQUIPMENT PROTECTION</b>   |  | <b>P</b> |               |                  |   |                 |   |                 |   |                 |   |                 |                |                  |   |                 |   |                 |  |   |
|   | This Clause provides information and considerations for the safe and proper operation of the utility-connected PV systems.   |  | P        |               |                  |   |                 |   |                 |   |                 |   |                 |                |                  |   |                 |   |                 |  |   |
| <b>5.1</b>                                | <b>Loss of utility voltage</b>   |  | <b>P</b> |               |                  |   |                 |   |                 |   |                 |   |                 |                |                  |   |                 |   |                 |  |   |
|   | To prevent islanding, a utility connected PV system ceases to energize the utility system from a de-energized distribution line irrespective of connected loads or other generators within specified time limits.  | Complied with IEC 62116, See the separate report for reference | P        |               |                  |   |                 |   |                 |   |                 |   |                 |                |                  |   |                 |   |                 |  |   |
|   | A utility distribution line can become de-energized for several reasons. For example, a substation breaker opening due to fault conditions or the distribution line switched out during maintenance.   |  | P        |               |                  |   |                 |   |                 |   |                 |   |                 |                |                  |   |                 |   |                 |  |   |
| <b>5.2</b>                                | <b>Over/under voltage and frequency</b>  |  | <b>P</b> |               |                  |   |                 |   |                 |   |                 |   |                 |                |                  |   |                 |   |                 |  |   |
|   | The abnormal utility conditions of concern are voltage and frequency excursions above or below the values stated in this Clause, and the complete disconnection of the utility, presenting the potential for a distributed resource island.  |  | P        |               |                  |   |                 |   |                 |   |                 |   |                 |                |                  |   |                 |   |                 |  |   |
| <b>5.2.1</b>                              | <b>Over/under voltage</b>  |  | <b>P</b> |               |                  |   |                 |   |                 |   |                 |   |                 |                |                  |   |                 |   |                 |  |   |
|   | When the interface voltage deviates outside the conditions specified in Table 2, the photovoltaic system ceases to energize the utility distribution system. This applies to any phase of a multiphase system.   | (See appended table)   | P        |               |                  |   |                 |   |                 |   |                 |   |                 |                |                  |   |                 |   |                 |  |   |

| IEC61727                                 |  |  |                    |                              |       |                        |       |                            |                      |                       |       |                 |        |  |   |
|--|--|--|--------------------|------------------------------|-------|------------------------|-------|----------------------------|----------------------|-----------------------|-------|-----------------|--------|--|---|
| Cl.                                      | Requirement - Test   | Result                                   | Verdict            |                              |       |                        |       |                            |                      |                       |       |                 |        |  |   |
|  | <p align="center"><b>Table 2 – Response to abnormal voltages</b></p> <table border="1"> <thead> <tr> <th>Voltage (at point of utility connection)</th> <th>Maximum trip time*</th> </tr> </thead> <tbody> <tr> <td><math>V &lt; 0,5 \times V_{nominal}</math></td> <td>0,1 s</td> </tr> <tr> <td><math>50 \% \leq V &lt; 85 \%</math></td> <td>2,0 s</td> </tr> <tr> <td><math>85 \% \leq V \leq 110 \%</math></td> <td>Continuous operation</td> </tr> <tr> <td><math>110 \% &lt; V &lt; 135 \%</math></td> <td>2,0 s</td> </tr> <tr> <td><math>135 \% \leq V</math></td> <td>0,05 s</td> </tr> </tbody> </table> <p>* Trip time refers to the time between the abnormal condition occurring and the inverter ceasing to energize the utility line. The PV system control circuits shall actually remain connected to the utility to allow sensing of utility electrical conditions for use by the "reconnect" feature.</p> | Voltage (at point of utility connection) | Maximum trip time* | $V < 0,5 \times V_{nominal}$ | 0,1 s | $50 \% \leq V < 85 \%$ | 2,0 s | $85 \% \leq V \leq 110 \%$ | Continuous operation | $110 \% < V < 135 \%$ | 2,0 s | $135 \% \leq V$ | 0,05 s |  | P |
| Voltage (at point of utility connection) | Maximum trip time*   |  |                    |                              |       |                        |       |                            |                      |                       |       |                 |        |  |   |
| $V < 0,5 \times V_{nominal}$             | 0,1 s  |  |                    |                              |       |                        |       |                            |                      |                       |       |                 |        |  |   |
| $50 \% \leq V < 85 \%$                   | 2,0 s  |  |                    |                              |       |                        |       |                            |                      |                       |       |                 |        |  |   |
| $85 \% \leq V \leq 110 \%$               | Continuous operation   |  |                    |                              |       |                        |       |                            |                      |                       |       |                 |        |  |   |
| $110 \% < V < 135 \%$                    | 2,0 s  |  |                    |                              |       |                        |       |                            |                      |                       |       |                 |        |  |   |
| $135 \% \leq V$                          | 0,05 s   |  |                    |                              |       |                        |       |                            |                      |                       |       |                 |        |  |   |
| <b>5.2.2</b>                             | <b>Over/under frequency</b>  |  | <b>P</b>           |                              |       |                        |       |                            |                      |                       |       |                 |        |  |   |
|  | When the utility frequency deviates outside the specified conditions the photovoltaic system ceases to energize the utility line. The unit does not have to cease to energize if the frequency returns to the normal utility continuous operation condition within the specified trip time.  | (See appended table)                     | P                  |                              |       |                        |       |                            |                      |                       |       |                 |        |  |   |
|  | When the utility frequency is outside the range of $\pm 1$ Hz, the system ceases to energize the utility line within 0,2 s. The purpose of the allowed range and time delay is to allow continued operation for short-term disturbances and to avoid excessive nuisance tripping in weak-utility system conditions.  |  | P                  |                              |       |                        |       |                            |                      |                       |       |                 |        |  |   |
| <b>5.3</b>                               | <b>Islanding protection</b>  |  | <b>P</b>           |                              |       |                        |       |                            |                      |                       |       |                 |        |  |   |
|  | The PV system must cease to energize the utility line within 2 s of loss of utility.   |  | P                  |                              |       |                        |       |                            |                      |                       |       |                 |        |  |   |
| <b>5.4</b>                               | <b>Response to utility recovery</b>  |  | <b>P</b>           |                              |       |                        |       |                            |                      |                       |       |                 |        |  |   |
|  | Following an out-of-range utility condition that has caused the photovoltaic system to cease energizing, the photovoltaic system is not energize the utility line for 20 s to 5 min after the utility service voltage and frequency have recovered to within the specified ranges.   | (See appended table)                     | P                  |                              |       |                        |       |                            |                      |                       |       |                 |        |  |   |
| <b>5.5</b>                               | <b>Earthing</b>  |  | <b>P</b>           |                              |       |                        |       |                            |                      |                       |       |                 |        |  |   |
|  | The utility interface equipment is earthed/grounded in accordance with IEC 60364-7-712.  |  | P                  |                              |       |                        |       |                            |                      |                       |       |                 |        |  |   |
| <b>5.6</b>                               | <b>Short circuit protection</b>  |  | <b>N/A</b>         |                              |       |                        |       |                            |                      |                       |       |                 |        |  |   |
|  | The photovoltaic system has short-circuit protection in accordance with IEC 60364-7-712.   | Should consider in the end use           | N/A                |                              |       |                        |       |                            |                      |                       |       |                 |        |  |   |
| <b>5.7</b>                               | <b>Isolation and switching</b>   |  | <b>N/A</b>         |                              |       |                        |       |                            |                      |                       |       |                 |        |  |   |
|  | A method of isolation and switching is provided in accordance with IEC 60364-7-712.  | Should consider in the end use           | N/A                |                              |       |                        |       |                            |                      |                       |       |                 |        |  |   |

| IEC61727 |                    |        |         |
|----------|--------------------|--------|---------|
| Cl.      | Requirement - Test | Result | Verdict |

| 4.3                        | TABLE: Flicker |          |           |            | P |
|----------------------------|----------------|----------|-----------|------------|---|
| Model: MAX 75KTL3-XL2      |                |          |           |            |   |
|                            | Starting       | Stopping | Running   |            |   |
| Limit                      | 4%             | 4%       | Pst = 1.0 | Plt = 0.65 |   |
| Test value L1-N            | 1.61           | 2.99     | 0.58      | 0.54       |   |
| Test value L2-N            | 0.73           | 2.86     | 0.59      | 0.55       |   |
| Test value L3-N            | 1.56           | 2.97     | 0.59      | 0.55       |   |
| Supplementary information: |                |          |           |            |   |

| 4.4                        | TABLE: Direct current injection  |  |            |            |           |           |           |                                 | P          |
|----------------------------|----------------------------------|--|------------|------------|-----------|-----------|-----------|---------------------------------|------------|
| Rated output current (A)   | Ratio of rated output power (VA) | Measured DC output current between terminals |            |            |           |           |           | Isolated transformer ? (Yes/No) | Limit (mA) |
|                            |                                  | L1-L2 (mA)                                   | L1-L3 (mA) | L2-L3 (mA) | L1-N (mA) | L2-N (mA) | L3-N (mA) |                                 |            |
| Model: MAX 75KTL3-XL2      |                                  |  |            |            |           |           |           |                                 |            |
| 196.9                      | 25%                              | --   | --         | --         | 215.7     | 109.0     | 120.0     | No                              | 1969       |
| 196.9                      | 50%                              | --   | --         | --         | 152.4     | 129.9     | 109.7     | No                              | 1969       |
| 196.9                      | 100%                             | --   | --         | --         | 582.2     | 565.3     | 517.7     | No                              | 1969       |
| Model: MAX 50KTL3-XL2      |                                  |  |            |            |           |           |           |                                 |            |
| 131.2                      | 25%                              | --   | --         | --         | 486.6     | 543.9     | 607.8     | No                              | 1312       |
| 131.2                      | 50%                              | --   | --         | --         | 497.2     | 458.9     | 442.7     | No                              | 1312       |
| 131.2                      | 100%                             | --   | --         | --         | 535.9     | 523.3     | 473.4     | No                              | 1312       |
| Supplementary information: |                                  |  |            |            |           |           |           |                                 |            |

| 4.6                   | TABLE: Harmonics and waveform distortion |                  |                    |                  |                    |                  |                             | P |
|-----------------------|--|------------------|--------------------|------------------|--------------------|------------------|-----------------------------|---|
| Model: MAX 75KTL3-XL2 |  |                  |                    |                  |                    |                  |                             |   |
| Harmonic              | fundamental L1 (A)                       | % of fundamental | fundamental L2 (A) | % of fundamental | fundamental L3 (A) | % of fundamental | Harmonic Current Limits (%) |   |
| 02                    | 0.2266                                   | 0.1150           | 0.3814             | 0.1950           | 0.1367             | 0.0700           | 1.0%                        |   |
| 03                    | 0.1721                                   | 0.0870           | 0.2336             | 0.1190           | 0.0611             | 0.0310           | 4.0%                        |   |

| IEC61727                   |                    |        |        |        |        |        |         |
|----------------------------|--------------------|--------|--------|--------|--------|--------|---------|
| Cl.                        | Requirement - Test |        |        | Result |        |        | Verdict |
| 04                         | 0.0808             | 0.0410 | 0.2005 | 0.1020 | 0.1947 | 0.0990 | 1.0%    |
| 05                         | 3.2068             | 1.6260 | 3.3086 | 1.6870 | 3.1664 | 1.6140 | 4.0%    |
| 06                         | 0.0604             | 0.0310 | 0.1152 | 0.0590 | 0.0354 | 0.0180 | 1.0%    |
| 07                         | 1.4608             | 0.7410 | 1.5422 | 0.7870 | 1.3969 | 0.7120 | 4.0%    |
| 08                         | 0.1153             | 0.0580 | 0.1279 | 0.0650 | 0.0400 | 0.0200 | 1.0%    |
| 09                         | 0.0739             | 0.0370 | 0.0337 | 0.0170 | 0.0909 | 0.0460 | 4.0%    |
| 10                         | 0.1132             | 0.0570 | 0.1368 | 0.0700 | 0.1026 | 0.0520 | 0.5%    |
| 11                         | 0.9060             | 0.4590 | 0.8268 | 0.4220 | 0.7467 | 0.3810 | 2.0%    |
| 12                         | 0.0852             | 0.0430 | 0.0994 | 0.0510 | 0.0952 | 0.0490 | 0.5%    |
| 13                         | 0.8945             | 0.4530 | 0.9354 | 0.4770 | 0.9098 | 0.4640 | 2.0%    |
| 14                         | 0.0512             | 0.0260 | 0.0207 | 0.0110 | 0.0606 | 0.0310 | 0.5%    |
| 15                         | 0.0663             | 0.0340 | 0.1000 | 0.0510 | 0.0634 | 0.0320 | 2.0%    |
| 16                         | 0.1032             | 0.0520 | 0.0936 | 0.0480 | 0.1050 | 0.0540 | 0.5%    |
| 17                         | 0.7812             | 0.3960 | 0.7098 | 0.3620 | 0.6849 | 0.3490 | 1.5%    |
| 18                         | 0.0544             | 0.0280 | 0.0094 | 0.0050 | 0.0707 | 0.0360 | 0.5%    |
| 19                         | 0.2055             | 0.1040 | 0.2316 | 0.1180 | 0.2439 | 0.1240 | 1.5%    |
| 20                         | 0.0586             | 0.0300 | 0.0806 | 0.0410 | 0.0215 | 0.0110 | 0.5%    |
| 21                         | 0.0418             | 0.0210 | 0.0337 | 0.0170 | 0.0346 | 0.0180 | 1.5%    |
| 22                         | 0.0145             | 0.0070 | 0.0337 | 0.0170 | 0.0080 | 0.0040 | 0.5%    |
| 23                         | 0.3791             | 0.1920 | 0.3900 | 0.1990 | 0.3871 | 0.1970 | 0.6%    |
| 24                         | 0.0016             | 0.0010 | 0.0067 | 0.0030 | 0.0073 | 0.0040 | 0.5%    |
| 25                         | 0.0967             | 0.0490 | 0.0858 | 0.0440 | 0.0925 | 0.0470 | 0.6%    |
| 26                         | 0.0475             | 0.0240 | 0.0413 | 0.0210 | 0.0308 | 0.0160 | 0.5%    |
| 27                         | 0.0184             | 0.0090 | 0.0134 | 0.0070 | 0.0085 | 0.0040 | 0.6%    |
| 28                         | 0.0467             | 0.0240 | 0.0219 | 0.0110 | 0.0285 | 0.0150 | 0.5%    |
| 29                         | 0.0642             | 0.0330 | 0.0830 | 0.0420 | 0.0721 | 0.0370 | 0.6%    |
| 30                         | 0.0283             | 0.0140 | 0.0387 | 0.0200 | 0.0091 | 0.0050 | 0.5%    |
| 31                         | 0.1072             | 0.0540 | 0.0982 | 0.0500 | 0.1058 | 0.0540 | 0.6%    |
| 32                         | 0.0075             | 0.0040 | 0.0290 | 0.0150 | 0.0159 | 0.0080 | 0.5%    |
| 33                         | 0.0407             | 0.0210 | 0.0262 | 0.0130 | 0.0203 | 0.0100 | 0.6%    |
| THD                        | 1.967              |        | 2.039  |        | 1.922  |        | 5%      |
| Supplementary information: |                    |        |        |        |        |        |         |

| IEC61727 |                    |        |         |
|----------|--------------------|--------|---------|
| Cl.      | Requirement - Test | Result | Verdict |

| 4.6                   | TABLE: Harmonics and waveform distortion |                  |                    |                  |                    |                  | P                           |
|-----------------------|--|------------------|--------------------|------------------|--------------------|------------------|-----------------------------|
| Model: MAX 50KTL3-XL2 |  |                  |                    |                  |                    |                  |                             |
| Harmonic              | fundamental L1 (A)                       | % of fundamental | fundamental L2 (A) | % of fundamental | fundamental L3 (A) | % of fundamental | Harmonic Current Limits (%) |
| 02                    | 0.1085                                   | 0.0820           | 0.2345             | 0.1790           | 0.1366             | 0.1040           | 1.0%                        |
| 03                    | 0.0724                                   | 0.0550           | 0.1052             | 0.0800           | 0.0461             | 0.0350           | 4.0%                        |
| 04                    | 0.0952                                   | 0.0720           | 0.1341             | 0.1020           | 0.1260             | 0.0960           | 1.0%                        |
| 05                    | 1.4840                                   | 1.1230           | 1.5372             | 1.1700           | 1.4581             | 1.1090           | 4.0%                        |
| 06                    | 0.0435                                   | 0.0330           | 0.0754             | 0.0570           | 0.0588             | 0.0450           | 1.0%                        |
| 07                    | 0.8371                                   | 0.6330           | 0.9378             | 0.7140           | 0.8570             | 0.6520           | 4.0%                        |
| 08                    | 0.0433                                   | 0.0330           | 0.0692             | 0.0530           | 0.0332             | 0.0250           | 1.0%                        |
| 09                    | 0.0361                                   | 0.0270           | 0.0271             | 0.0210           | 0.0675             | 0.0510           | 4.0%                        |
| 10                    | 0.0115                                   | 0.0090           | 0.0566             | 0.0430           | 0.0654             | 0.0500           | 0.5%                        |
| 11                    | 0.5575                                   | 0.4220           | 0.5276             | 0.4020           | 0.4949             | 0.3770           | 2.0%                        |
| 12                    | 0.0673                                   | 0.0510           | 0.0855             | 0.0650           | 0.0683             | 0.0520           | 0.5%                        |
| 13                    | 0.4533                                   | 0.3430           | 0.4605             | 0.3510           | 0.4722             | 0.3590           | 2.0%                        |
| 14                    | 0.0546                                   | 0.0410           | 0.0302             | 0.0230           | 0.0387             | 0.0290           | 0.5%                        |
| 15                    | 0.0280                                   | 0.0210           | 0.0137             | 0.0100           | 0.0343             | 0.0260           | 2.0%                        |
| 16                    | 0.0411                                   | 0.0310           | 0.0446             | 0.0340           | 0.0077             | 0.0060           | 0.5%                        |
| 17                    | 0.6799                                   | 0.5140           | 0.6253             | 0.4760           | 0.6337             | 0.4820           | 1.5%                        |
| 18                    | 0.0280                                   | 0.0210           | 0.0309             | 0.0240           | 0.0342             | 0.0260           | 0.5%                        |
| 19                    | 0.1276                                   | 0.0970           | 0.1231             | 0.0940           | 0.1045             | 0.0800           | 1.5%                        |
| 20                    | 0.0406                                   | 0.0310           | 0.0573             | 0.0440           | 0.0133             | 0.0100           | 0.5%                        |
| 21                    | 0.0252                                   | 0.0190           | 0.0189             | 0.0140           | 0.0069             | 0.0050           | 1.5%                        |
| 22                    | 0.0167                                   | 0.0130           | 0.0219             | 0.0170           | 0.0280             | 0.0210           | 0.5%                        |
| 23                    | 0.2891                                   | 0.2190           | 0.2797             | 0.2130           | 0.2477             | 0.1880           | 0.6%                        |
| 24                    | 0.0251                                   | 0.0190           | 0.0264             | 0.0200           | 0.0378             | 0.0290           | 0.5%                        |
| 25                    | 0.0961                                   | 0.0730           | 0.1082             | 0.0820           | 0.0522             | 0.0400           | 0.6%                        |
| 26                    | 0.0131                                   | 0.0100           | 0.0431             | 0.0330           | 0.0266             | 0.0200           | 0.5%                        |
| 27                    | 0.0304                                   | 0.0230           | 0.0084             | 0.0060           | 0.0198             | 0.0150           | 0.6%                        |
| 28                    | 0.0420                                   | 0.0320           | 0.0503             | 0.0380           | 0.0717             | 0.0550           | 0.5%                        |
| 29                    | 0.0451                                   | 0.0340           | 0.0461             | 0.0350           | 0.0670             | 0.0510           | 0.6%                        |

| IEC61727                   |                    |        |        |        |        |        |         |
|----------------------------|--------------------|--------|--------|--------|--------|--------|---------|
| Cl.                        | Requirement - Test |        |        | Result |        |        | Verdict |
| 30                         | 0.0197             | 0.0150 | 0.0246 | 0.0190 | 0.0189 | 0.0140 | 0.5%    |
| 31                         | 0.0624             | 0.0470 | 0.1120 | 0.0850 | 0.0753 | 0.0570 | 0.6%    |
| 32                         | 0.0039             | 0.0030 | 0.0193 | 0.0150 | 0.0355 | 0.0270 | 0.5%    |
| 33                         | 0.0189             | 0.0140 | 0.0162 | 0.0120 | 0.0378 | 0.0290 | 0.6%    |
| THD                        | 1.530              |        | 1.596  |        | 1.507  |        | 5%      |
| Supplementary information: |                    |        |        |        |        |        |         |

| 4.7  | TABLE: Power factor |                  |           |                  |                  |           |                    | P                  |
|--|---------------------|------------------|-----------|------------------|------------------|-----------|--------------------|--------------------|
| Model: MAX 75KTL3-XL2  |                     |                  |           |                  |                  |           |                    |                    |
| No   | Input               |                  |           | Output           |                  |           |                    | Rated output (V.A) |
|  | Voltage (V d.c.)    | Current (A d.c.) | Power (W) | Voltage (V a.c.) | Current (A a.c.) | Power (W) | Power factor (+/-) |                    |
| 1  | 362.38              | 44.59            | 16155.43  | 126.32           | 40.16            | 15163.87  | 0.9963             | (20±5)%            |
| 2  | 362.15              | 66.08            | 23929.70  | 126.51           | 60.00            | 22707.25  | 0.9972             | (30±5)%            |
| 3  | 361.78              | 87.82            | 31769.51  | 126.70           | 79.81            | 30263.72  | 0.9977             | (40±5)%            |
| 4  | 127.04              | 99.78            | 12650.93  | 126.88           | 99.40            | 37755.57  | 0.9979             | (50±5)%            |
| 5  | 361.15              | 131.34           | 47431.11  | 127.07           | 118.83           | 45212.32  | 0.9981             | (60±5)%            |
| 6  | 360.94              | 153.26           | 55315.67  | 127.26           | 138.35           | 52717.43  | 0.9981             | (70±5)%            |
| 7  | 360.57              | 175.43           | 63254.93  | 127.44           | 157.83           | 60225.20  | 0.9980             | (80±5)%            |
| 8  | 360.26              | 197.81           | 71260.83  | 127.64           | 177.29           | 67762.75  | 0.9982             | (90±5)%            |
| 9  | 360.00              | 220.18           | 79262.55  | 127.84           | 196.57           | 75255.32  | 0.9982             | (100±5)%           |
| Supplementary information:   |                     |                  |           |                  |                  |           |                    |                    |
| Power factor with "+" indicating leading and "-" indicating lagging. |                     |                  |           |                  |                  |           |                    |                    |

| 4.7                   | TABLE: Power factor |                  |           |                  |                  |           |                    | P                  |
|-----------------------|---------------------|------------------|-----------|------------------|------------------|-----------|--------------------|--------------------|
| Model: MAX 50KTL3-XL2 |                     |                  |           |                  |                  |           |                    |                    |
| No                    | Input               |                  |           | Output           |                  |           |                    | Rated output (V.A) |
|                       | Voltage (V d.c.)    | Current (A d.c.) | Power (W) | Voltage (V a.c.) | Current (A a.c.) | Power (W) | Power factor (+/-) |                    |
| 1                     | 362.62              | 29.90            | 10841.99  | 126.19           | 26.54            | 9994.20   | 0.9947             | (20±5)%            |
| 2                     | 362.38              | 44.33            | 16063.72  | 126.33           | 39.93            | 15079.91  | 0.9965             | (30±5)%            |

| IEC61727   |                    |        |          |        |        |          |        |          |
|--|--------------------|--------|----------|--------|--------|----------|--------|----------|
| Cl.  | Requirement - Test |        |          |        |        | Result   |        | Verdict  |
| 3  | 362.19             | 58.82  | 21304.75 | 126.45 | 53.11  | 20088.39 | 0.9970 | (40±5)%  |
| 4  | 361.95             | 73.20  | 26493.21 | 126.58 | 66.31  | 25113.15 | 0.9974 | (50±5)%  |
| 5  | 361.76             | 87.67  | 31715.18 | 126.71 | 79.46  | 30135.95 | 0.9977 | (60±5)%  |
| 6  | 361.62             | 102.15 | 36939.44 | 126.84 | 92.61  | 35160.84 | 0.9978 | (70±5)%  |
| 7  | 361.43             | 116.69 | 42175.56 | 126.97 | 105.70 | 40180.35 | 0.9979 | (80±5)%  |
| 8  | 361.24             | 131.35 | 47446.70 | 126.89 | 119.01 | 45215.89 | 0.9981 | (90±5)%  |
| 9  | 361.01             | 145.54 | 52541.17 | 127.01 | 131.64 | 50063.54 | 0.9982 | (100±5)% |
| Supplementary information:<br>Power factor with "+" indicating leading and "-" indicating lagging. |                    |        |          |        |        |          |        |          |

| IEC61727 |                    |        |         |
|----------|--------------------|--------|---------|
| Cl.      | Requirement - Test | Result | Verdict |

| <b>5.2.1 &amp; 5.4</b>                                       |                   | <b>TABLE: Under-and over-voltage trip settings and reconnection test</b> |                                |                            |                       |                              |                                 | <b>P</b> |
|--|-------------------|--|--------------------------------|----------------------------|-----------------------|------------------------------|---------------------------------|----------|
| <b>(1) Under voltage disconnection procedure</b>             |                   |  |                                |                            |                       |                              |                                 |          |
| Rated output voltage (V)                                     | Output power (VA) | Required min. voltage (V)  | Value of PCE trip settings (V) | Ratio of decreased (V / s) | Interval time (s)     | Measured tripped voltage (V) | Measured disconnection time (s) |          |
| 127  | 75K               | 107.95   | 108.0                          | 0.10                       | 4                     | 106.98                       | 1.49                            |          |
| Rated output voltage (V)                                     | Output power (VA) | Required min. voltage (V)  | Value of PCE trip settings (V) | Ratio of decreased (V / s) | Interval time (s)     | Measured tripped voltage (V) | Measured disconnection time (s) |          |
| 127  | 75K               | 63.5   | 63.0                           | 0.10                       | 0.1                   | 63.90                        | 0.063                           |          |
| <b>(2) Under voltage reconnection procedure</b>              |                   |  |                                |                            |                       |                              |                                 |          |
| Ratio of voltage rapidly decreased (V / s)                   |                   |  | Reconnection voltage (V)       |                            | Reconnection time (s) |                              |                                 |          |
| 0.10   |                   |  | >108                           |                            | 81.2                  |                              |                                 |          |
| <b>(3) Over voltage disconnection procedure</b>              |                   |  |                                |                            |                       |                              |                                 |          |
| Rated output voltage (V)                                     | Output power (VA) | Required max. voltage (V)  | Value of PCE trip settings (V) | Ratio of increased (V / s) | Interval time (s)     | Measured tripped voltage (V) | Measured disconnection time (s) |          |
| 127  | 75K               | 139.7  | 140                            | 0.10                       | 4                     | 139.7                        | 1.50                            |          |
| Rated output voltage (V)                                     | Output power (VA) | Required max. voltage (V)  | Value of PCE trip settings (V) | Ratio of increased (V / s) | Interval time (s)     | Measured tripped voltage (V) | Measured disconnection time (s) |          |
| 127  | 75K               | 171.5  | 172                            | 0.10                       | 0.1                   | 172.2                        | 0.032                           |          |
| <b>(4) Over voltage reconnection procedure</b>               |                   |  |                                |                            |                       |                              |                                 |          |
| Ratio of voltage rapidly decreased (V / s)                   |                   |  | Reconnection voltage (V)       |                            | Reconnection time (s) |                              |                                 |          |
| 0.10   |                   |  | <139                           |                            | 80.90                 |                              |                                 |          |
| Supplementary information:<br>Tested on model MAX 75KTL3-XL2 |                   |  |                                |                            |                       |                              |                                 |          |

|          |                    |        |         |
|----------|--------------------|--------|---------|
| IEC61727 |                    |        |         |
| Cl.      | Requirement - Test | Result | Verdict |

| <b>5.2.2 &amp; 5.4</b>                             |                   | <b>TABLE: Over/under frequency trip settings and reconnection test</b> |                                 |                             |                       |                                 |                                 | <b>P</b> |
|--|-------------------|--|---------------------------------|-----------------------------|-----------------------|---------------------------------|---------------------------------|----------|
| <b>(1) Under frequency disconnection procedure</b> |                   |  |                                 |                             |                       |                                 |                                 |          |
| Rated output frequency (Hz)                        | Output power (VA) | Required min. frequency (Hz)   | Value of PCE trip settings (Hz) | Ratio of decreased (Hz / s) | Interval time (s)     | Measured tripped frequency (Hz) | Measured disconnection time (s) |          |
| 60   | 75K               | 59   | 59                              | 0.01                        | 0.3                   | 59.01                           | 0.185                           |          |
| <b>(2) Under frequency reconnection procedure</b>  |                   |  |                                 |                             |                       |                                 |                                 |          |
| Ratio of frequency rapidly decreased (Hz / s)      |                   |  | Reconnection frequency (Hz)     |                             | Reconnection time (s) |                                 |                                 |          |
| 0.01   |                   |  | >59                             |                             | 82.2                  |                                 |                                 |          |
| <b>(3) Over frequency disconnection procedure</b>  |                   |  |                                 |                             |                       |                                 |                                 |          |
| Rated output frequency (Hz)                        | Output power (VA) | Required max. frequency (Hz)   | Value of PCE trip settings (Hz) | Ratio of increased (Hz / s) | Interval time (s)     | Measured tripped frequency (Hz) | Measured disconnection time (s) |          |
| 60   | 75K               | 61   | 61                              | 0.01                        | 0.3                   | 60.96                           | 0.182                           |          |
| <b>(4) Over frequency reconnection procedure</b>   |                   |  |                                 |                             |                       |                                 |                                 |          |
| Ratio of frequency rapidly decreased (Hz / s)      |                   |  | Reconnection frequency (Hz)     |                             | Reconnection time (s) |                                 |                                 |          |
| 0.01   |                   |  | <61                             |                             | 80.8                  |                                 |                                 |          |
| Supplementary information:                         |                   |  |                                 |                             |                       |                                 |                                 |          |
| Tested on model MAX 75KTL3-XL2 with frequency 60Hz |                   |  |                                 |                             |                       |                                 |                                 |          |

|          |                    |        |         |
|----------|--------------------|--------|---------|
| IEC61727 |                    |        |         |
| Cl.      | Requirement - Test | Result | Verdict |

| <b>5.2.2 &amp; 5.4</b>                             |                   | <b>TABLE: Over/under frequency trip settings and reconnection test</b> |                                 |                             |                       |                                 |                                 | <b>P</b> |
|--|-------------------|--|---------------------------------|-----------------------------|-----------------------|---------------------------------|---------------------------------|----------|
| <b>(1) Under frequency disconnection procedure</b> |                   |  |                                 |                             |                       |                                 |                                 |          |
| Rated output frequency (Hz)                        | Output power (VA) | Required min. frequency (Hz)   | Value of PCE trip settings (Hz) | Ratio of decreased (Hz / s) | Interval time (s)     | Measured tripped frequency (Hz) | Measured disconnection time (s) |          |
| 50   | 75K               | 49   | 49                              | 0.01                        | 0.3                   | 49.01                           | 0.176                           |          |
| <b>(2) Under frequency reconnection procedure</b>  |                   |  |                                 |                             |                       |                                 |                                 |          |
| Ratio of frequency rapidly decreased (Hz / s)      |                   |  | Reconnection frequency (Hz)     |                             | Reconnection time (s) |                                 |                                 |          |
| 0.01   |                   |  | >49                             |                             | 79.0                  |                                 |                                 |          |
| <b>(3) Over frequency disconnection procedure</b>  |                   |  |                                 |                             |                       |                                 |                                 |          |
| Rated output frequency (Hz)                        | Output power (VA) | Required max. frequency (Hz)   | Value of PCE trip settings (Hz) | Ratio of increased (Hz / s) | Interval time (s)     | Measured tripped frequency (Hz) | Measured disconnection time (s) |          |
| 50   | 75K               | 51   | 51                              | 0.01                        | 0.3                   | 50.99                           | 0.193                           |          |
| <b>(4) Over frequency reconnection procedure</b>   |                   |  |                                 |                             |                       |                                 |                                 |          |
| Ratio of frequency rapidly decreased (Hz / s)      |                   |  | Reconnection frequency (Hz)     |                             | Reconnection time (s) |                                 |                                 |          |
| 0.01   |                   |  | <51                             |                             | 79.0                  |                                 |                                 |          |
| Supplementary information:                         |                   |  |                                 |                             |                       |                                 |                                 |          |
| Tested on model MAX 75KTL3-XL2 with frequency 50Hz |                   |  |                                 |                             |                       |                                 |                                 |          |

| IEC61727 |                    |        |         |
|----------|--------------------|--------|---------|
| Cl.      | Requirement - Test | Result | Verdict |

| 5.3   | TABLE: tested condition and run-on time |                             |                 |                 |                 |                       |                             |                     | P  |
|---|---|-----------------------------|-----------------|-----------------|-----------------|-----------------------|-----------------------------|---------------------|--|
| Model: Tested on model MAX 75KTL3-XL2 with frequency 50Hz |   |                             |                 |                 |                 |                       |                             |                     |  |
| No.   | P <sub>EUT</sub> (% of EUT rating)      | Reactive load (% of normal) | P <sub>AC</sub> | Q <sub>AC</sub> | Run-on time(ms) | P <sub>EUT</sub> (KW) | Actual Q <sub>f</sub> (Var) | V <sub>DC</sub> (V) | Which load is selected to be adjusted (R or L) |
| Test condition A  |   |                             |                 |                 |                 |                       |                             |                     |  |
| 1   | 100                                     | 100                         | 0               | 0               | 459.5           | 75.11                 | 1.00                        | 800                 | /  |
| 2   | 100                                     | 100                         | -5              | -5              | 332.5           | 75.11                 | 0.98                        | 800                 | /  |
| 3   | 100                                     | 100                         | -5              | 0               | 279.5           | 75.11                 | 0.95                        | 800                 | /  |
| 4   | 100                                     | 100                         | -5              | +5              | 305.0           | 75.11                 | 0.93                        | 800                 | /  |
| 5   | 100                                     | 100                         | 0               | -5              | 401.0           | 75.11                 | 1.03                        | 800                 | /  |
| 6   | 100                                     | 100                         | 0               | +5              | 311.5           | 75.11                 | 0.98                        | 800                 | /  |
| 7   | 100                                     | 100                         | +5              | -5              | 258.5           | 75.11                 | 1.08                        | 800                 | /  |
| 8   | 100                                     | 100                         | +5              | 0               | 279.5           | 75.11                 | 1.06                        | 800                 | /  |
| 9   | 100                                     | 100                         | +5              | +5              | 157.5           | 75.11                 | 1.03                        | 800                 | /  |
| Test condition B  |   |                             |                 |                 |                 |                       |                             |                     |  |
| 10  | 66                                      | 66                          | 0               | 0               | 299.5           | 49.68                 | 1.00                        | 520                 | /  |
| 11  | 66                                      | 66                          | 0               | -5              | 196.0           | 49.68                 | 1.03                        | 520                 | L  |
| 12  | 66                                      | 66                          | 0               | -4              | 292.0           | 49.68                 | 1.02                        | 520                 | L  |
| 13  | 66                                      | 66                          | 0               | -3              | 287.5           | 49.68                 | 1.02                        | 520                 | L  |
| 14  | 66                                      | 66                          | 0               | -2              | 243.5           | 49.68                 | 1.01                        | 520                 | L  |
| 15  | 66                                      | 66                          | 0               | -1              | 242.0           | 49.68                 | 1.01                        | 520                 | L  |
| 16  | 66                                      | 66                          | 0               | 1               | 308.0           | 49.68                 | 0.99                        | 520                 | L  |
| 17  | 66                                      | 66                          | 0               | 2               | 464.0           | 49.68                 | 0.99                        | 520                 | L  |
| 18  | 66                                      | 66                          | 0               | 3               | 415.5           | 49.68                 | 0.98                        | 520                 | L  |
| 19  | 66                                      | 66                          | 0               | 4               | 409.5           | 49.68                 | 0.98                        | 520                 | L  |
| 20  | 66                                      | 66                          | 0               | 5               | 311.5           | 49.68                 | 0.97                        | 520                 | L  |
| Test condition C  |   |                             |                 |                 |                 |                       |                             |                     |  |
| 21  | 33                                      | 33                          | 0               | 0               | 838.0           | 24.81                 | 1.00                        | 309                 | /  |
| 22  | 33                                      | 33                          | 0               | -5              | 529.0           | 24.81                 | 1.03                        | 309                 | L  |
| 23  | 33                                      | 33                          | 0               | -4              | 668.0           | 24.81                 | 1.02                        | 309                 | L  |
| 24  | 33                                      | 33                          | 0               | -3              | 832.0           | 24.81                 | 1.02                        | 309                 | L  |
| 25  | 33                                      | 33                          | 0               | -2              | 652.0           | 24.81                 | 1.01                        | 309                 | L  |
| 26  | 33                                      | 33                          | 0               | -1              | 770.0           | 24.81                 | 1.01                        | 309                 | L  |
| 27  | 33                                      | 33                          | 0               | 1               | 716.0           | 24.81                 | 0.99                        | 309                 | L  |
| 28  | 33                                      | 33                          | 0               | 2               | 600.0           | 24.81                 | 0.99                        | 309                 | L  |
| 29  | 33                                      | 33                          | 0               | 3               | 858.0           | 24.81                 | 0.98                        | 309                 | L  |
| 30  | 33                                      | 33                          | 0               | 4               | 612.0           | 24.81                 | 0.98                        | 309                 | L  |
| 31  | 33                                      | 33                          | 0               | 5               | 460.0           | 24.81                 | 0.97                        | 309                 | L  |

| IEC61727 |                    |        |         |
|----------|--------------------|--------|---------|
| Cl.      | Requirement - Test | Result | Verdict |

Supplementary information:

For test condition A:

If any of the recorded run-on times are longer than the one recorded for the rated balance condition, then the non-shaded parameter combinations also require testing.

For test condition B and C:

If run-on times are still increasing at the 95 % or 105 % points, additional 1 % increments is taken until run-on times begin decreasing.

| IEC61727 |                    |        |         |
|----------|--------------------|--------|---------|
| Cl.      | Requirement - Test | Result | Verdict |

| 5.3   | TABLE: tested condition and run-on time |                             |                 |                 |                 |                       |                             |                     | P  |
|---|---|-----------------------------|-----------------|-----------------|-----------------|-----------------------|-----------------------------|---------------------|--|
| Model: Tested on model MAX 75KTL3-XL2 with frequency 60Hz |   |                             |                 |                 |                 |                       |                             |                     |  |
| No.   | P <sub>EUT</sub> (% of EUT rating)      | Reactive load (% of normal) | P <sub>AC</sub> | Q <sub>AC</sub> | Run-on time(ms) | P <sub>EUT</sub> (KW) | Actual Q <sub>f</sub> (Var) | V <sub>DC</sub> (V) | Which load is selected to be adjusted (R or L) |
| Test condition A  |   |                             |                 |                 |                 |                       |                             |                     |  |
| 1   | 100                                     | 100                         | 0               | 0               | 730.0           | 75.11                 | 1.00                        | 800                 | /  |
| 2   | 100                                     | 100                         | -5              | -5              | 330.0           | 75.11                 | 0.97                        | 800                 | /  |
| 3   | 100                                     | 100                         | -5              | 0               | 484.0           | 75.11                 | 0.95                        | 800                 | /  |
| 4   | 100                                     | 100                         | -5              | +5              | 414.0           | 75.11                 | 0.93                        | 800                 | /  |
| 5   | 100                                     | 100                         | 0               | -5              | 322.0           | 75.11                 | 1.03                        | 800                 | /  |
| 6   | 100                                     | 100                         | 0               | +5              | 256.0           | 75.11                 | 0.98                        | 800                 | /  |
| 7   | 100                                     | 100                         | +5              | -5              | 260.0           | 75.11                 | 1.08                        | 800                 | /  |
| 8   | 100                                     | 100                         | +5              | 0               | 648.0           | 75.11                 | 1.06                        | 800                 | /  |
| 9   | 100                                     | 100                         | +5              | +5              | 588.0           | 75.11                 | 1.04                        | 800                 | /  |
| Test condition B  |   |                             |                 |                 |                 |                       |                             |                     |  |
| 10  | 66                                      | 66                          | 0               | 0               | 335.5           | 49.68                 | 1.00                        | 520                 | /  |
| 11  | 66                                      | 66                          | 0               | -5              | 259.0           | 49.68                 | 1.03                        | 520                 | L  |
| 12  | 66                                      | 66                          | 0               | -4              | 327.0           | 49.68                 | 1.02                        | 520                 | L  |
| 13  | 66                                      | 66                          | 0               | -3              | 373.5           | 49.68                 | 1.02                        | 520                 | L  |
| 14  | 66                                      | 66                          | 0               | -2              | 327.5           | 49.68                 | 1.01                        | 520                 | L  |
| 15  | 66                                      | 66                          | 0               | -1              | 285.5           | 49.68                 | 1.01                        | 520                 | L  |
| 16  | 66                                      | 66                          | 0               | 1               | 313.0           | 49.68                 | 0.99                        | 520                 | L  |
| 17  | 66                                      | 66                          | 0               | 2               | 629.0           | 49.68                 | 0.99                        | 520                 | L  |
| 18  | 66                                      | 66                          | 0               | 3               | 327.0           | 49.68                 | 0.98                        | 520                 | L  |
| 19  | 66                                      | 66                          | 0               | 4               | 411.0           | 49.68                 | 0.98                        | 520                 | L  |
| 20  | 66                                      | 66                          | 0               | 5               | 299.0           | 49.68                 | 0.97                        | 520                 | L  |
| Test condition C  |   |                             |                 |                 |                 |                       |                             |                     |  |
| 21  | 33                                      | 33                          | 0               | 0               | 530.0           | 24.81                 | 1.00                        | 309                 | /  |
| 22  | 33                                      | 33                          | 0               | -5              | 134.5           | 24.81                 | 1.03                        | 309                 | L  |
| 23  | 33                                      | 33                          | 0               | -4              | 192.5           | 24.81                 | 1.02                        | 309                 | L  |
| 24  | 33                                      | 33                          | 0               | -3              | 178.5           | 24.81                 | 1.02                        | 309                 | L  |
| 25  | 33                                      | 33                          | 0               | -2              | 226.5           | 24.81                 | 1.01                        | 309                 | L  |
| 26  | 33                                      | 33                          | 0               | -1              | 234.5           | 24.81                 | 1.01                        | 309                 | L  |
| 27  | 33                                      | 33                          | 0               | 1               | 235.5           | 24.81                 | 0.99                        | 309                 | L  |
| 28  | 33                                      | 33                          | 0               | 2               | 153.5           | 24.81                 | 0.99                        | 309                 | L  |
| 29  | 33                                      | 33                          | 0               | 3               | 182.5           | 24.81                 | 0.98                        | 309                 | L  |
| 30  | 33                                      | 33                          | 0               | 4               | 176.5           | 24.81                 | 0.98                        | 309                 | L  |
| 31  | 33                                      | 33                          | 0               | 5               | 175.5           | 24.81                 | 0.97                        | 309                 | L  |

| IEC61727 |                    |        |         |
|----------|--------------------|--------|---------|
| Cl.      | Requirement - Test | Result | Verdict |

Supplementary information:  
For test condition A:  
If any of the recorded run-on times are longer than the one recorded for the rated balance condition, then the non-shaded parameter combinations also require testing.  
For test condition B and C:  
If run-on times are still increasing at the 95 % or 105 % points, additional 1 % increments is taken until run-on times begin decreasing.

**Appendix 1: Photos**



Top view of the unit

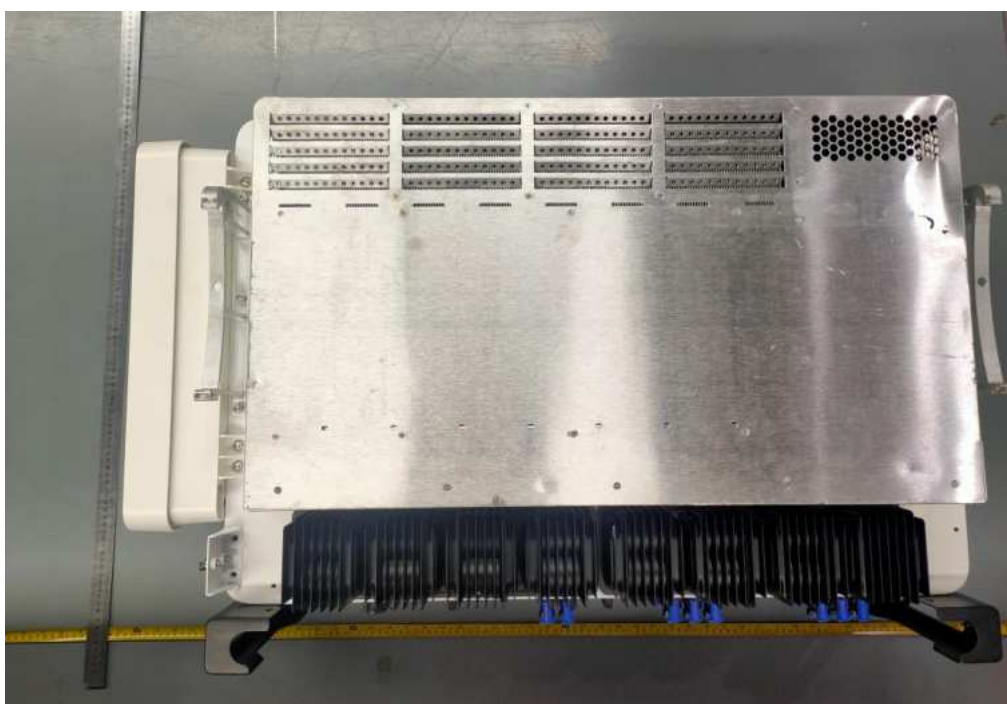

Back view of the unit

**Appendix 1: Photos**



PV Input Terminal view



Side view

**Appendix 1: Photos**

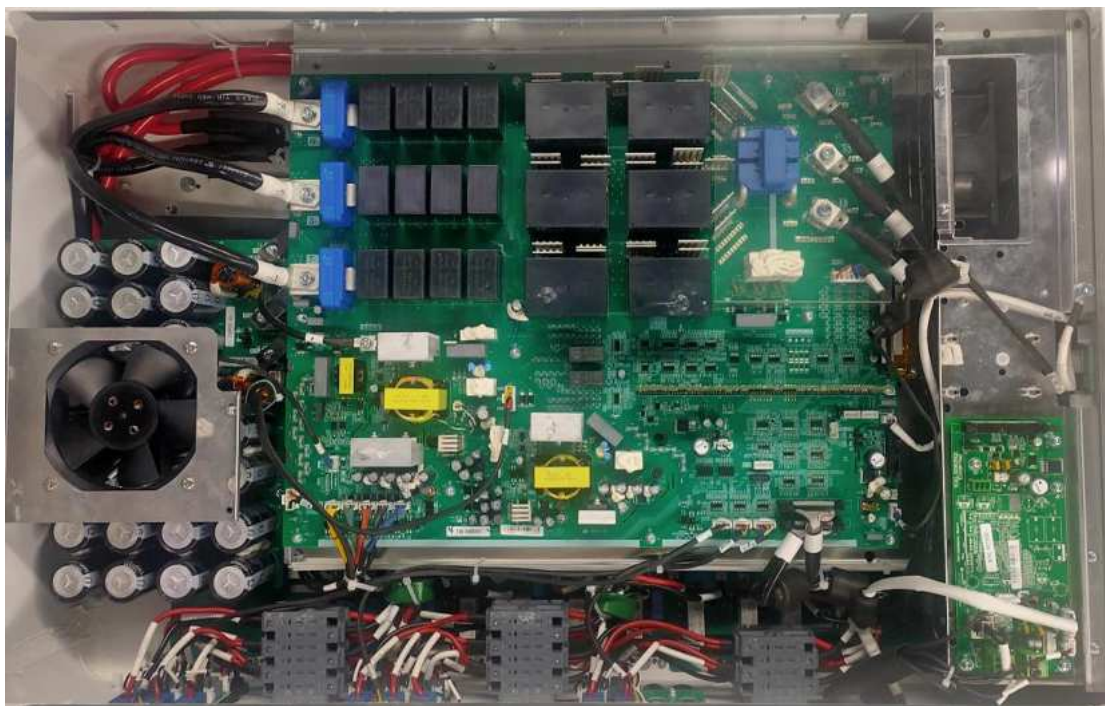

Internal view

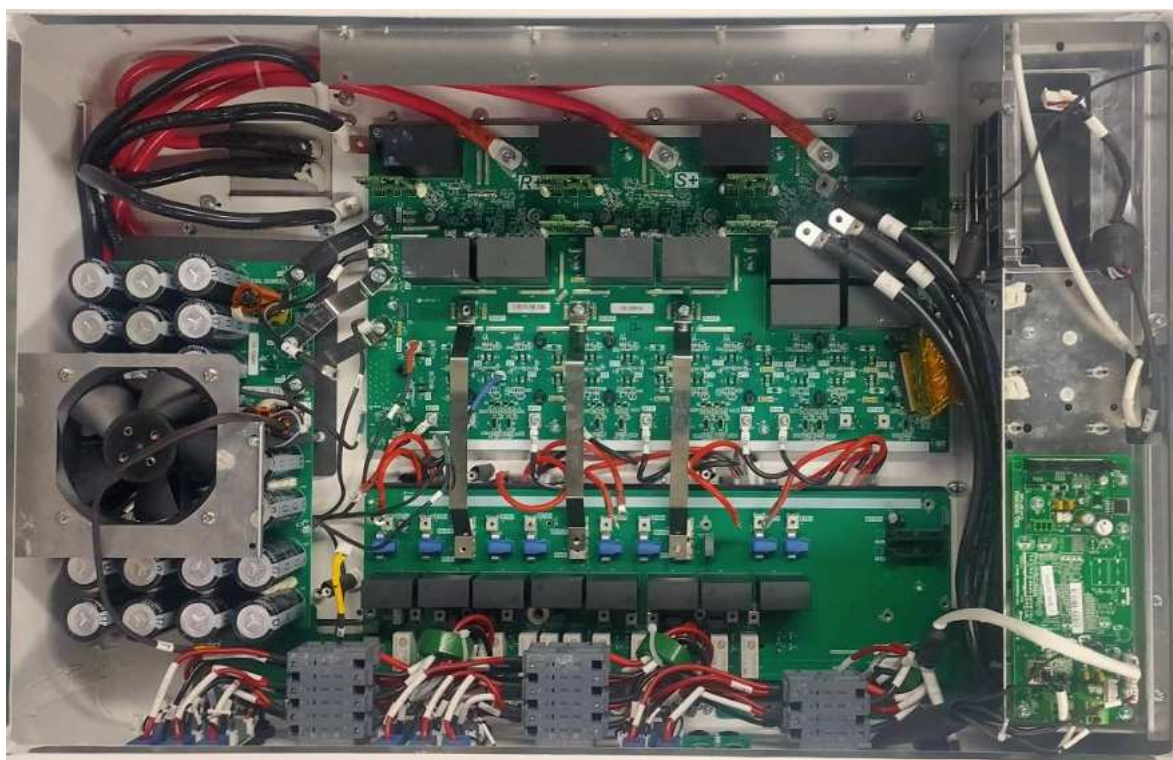

Internal view

--- End of test report---



TL-395

Test Report issued under the responsibility of:



Total Quality. Assured.

|  |   |
|--|---|
| <b>TEST REPORT<br/>IEC 62116<br/>Test procedure of islanding prevention measures for utility-interconnected photovoltaic inverters</b>   |   |
| <b>Report Number</b> .....   | 220308046GZU-002  |
| <b>Date of issue</b> .....   | 30 May 2022   |
| <b>Total number of pages</b> .....   | 18 Pages  |
| <b>Name of Testing Laboratory preparing the Report</b> .....   | Intertek Testing Services Shenzhen Ltd. Guangzhou Branch<br>Room 02, & 101/E201/E301/E401/E501/E601/E701/E801 of Room 01 1-8/F., No. 7-2. Caipin Road, Science City, GETDD, Guangzhou, Guangdong, China |
| <b>Applicant's name</b> .....  | Shenzhen Growatt New Energy Co., Ltd.   |
| <b>Address</b> .....   | 4-13/F, Building A, Sino-German (Europe) Industrial Park, Hangcheng Ave, Bao'an District, Shenzhen, China   |
| <b>Test specification:</b>   |   |
| <b>Standard</b> .....  | IEC 62116:2014  |
| <b>Test procedure</b> .....  | Type approval   |
| <b>Non-standard test method</b> .....  | N/A   |
| <b>Test Report Form No.</b> .....  | IEC62116B   |
| <b>Test Report Form(s) Originator</b> .....  | TÜV SÜD Product Service GmbH  |
| <b>Master TRF</b> .....  | Dated 2017-11-03  |
| <b>Copyright © 2017 IEC System of Conformity Assessment Schemes for Electrotechnical Equipment and Components (IECEE System). All rights reserved.</b>   |   |
| This publication may be reproduced in whole or in part for non-commercial purposes as long as the IECEE is acknowledged as copyright owner and source of the material. IECEE takes no responsibility for and will not assume liability for damages resulting from the reader's interpretation of the reproduced material due to its placement and context. |   |
| If this Test Report Form is used by non-IECEE members, the IECEE/IEC logo and the reference to the CB Scheme procedure shall be removed.   |   |
| <b>This report is not valid as a CB Test Report unless signed by an approved CB Testing Laboratory and appended to a CB Test Certificate issued by an NCB in accordance with IECEE 02.</b>   |   |
| <b>General disclaimer:</b>   |   |
| The test results presented in this report relate only to the object tested.<br>This report shall not be reproduced, except in full, without the written approval of the Issuing CB Testing Laboratory. The authenticity of this Test Report and its contents can be verified by contacting the NCB, responsible for this Test Report.                      |   |

|                                |   |                       |                       |                       |                       |                       |
|--------------------------------|---|-----------------------|-----------------------|-----------------------|-----------------------|-----------------------|
| <b>Test item description :</b> | PV Grid inverter  |                       |                       |                       |                       |                       |
| <b>Trade Mark .....</b>        | GROWATT   |                       |                       |                       |                       |                       |
| <b>Manufacturer .....</b>      | Same as applicant   |                       |                       |                       |                       |                       |
| <b>Model/Type reference :</b>  | MAX 50KTL3-XL2, MAX 60KTL3-XL2, MAX 70KTL3-XL2, MAX 73KTL3-XL2<br>MAX 75KTL3-XL2, MAX 50KTL3-XL1, MAX 60KTL3-XL1, MAX 70KTL3-XL1,<br>MAX 73KTL3-XL1, MAX 75KTL3-XL1 |                       |                       |                       |                       |                       |
| <b>Ratings .....</b>           | Model   | MAX<br>50KTL3-<br>XL2 | MAX<br>60KTL3-<br>XL2 | MAX<br>70KTL3-<br>XL2 | MAX<br>73KTL3-<br>XL2 | MAX<br>75KTL3-<br>XL2 |
|                                | Max.PV<br>voltage   | 1100Vdc               |                       |                       |                       |                       |
|                                | MPPT<br>voltage   | 180-850Vdc            |                       |                       |                       |                       |
|                                | Max.input<br>current  | 8*45A                 |                       |                       |                       |                       |
|                                | PV Isc  | 8*56.5A               |                       |                       |                       |                       |
|                                | Nominal<br>output<br>voltage  | 3W/N/PE, 127/220Vac   |                       |                       |                       |                       |
|                                | Nominal<br>output<br>Frequency  | 50/60Hz               |                       |                       |                       |                       |
|                                | Max.output<br>current   | 144.3A                | 173.2A                | 183.7A                | 191.6A                | 196.9A                |
|                                | Max. output<br>power  | 50KW                  | 60KW                  | 70KW                  | 73KW                  | 75KW                  |
|                                | Max.<br>apparent<br>power   | 55KVA                 | 66KVA                 | 70KVA                 | 73KVA                 | 75KVA                 |
|                                | Power factor<br>range   | 0.8Leading~0.8Lagging |                       |                       |                       |                       |
|                                | Safety level  | Class I               |                       |                       |                       |                       |
|                                | Ingress<br>Protection   | IP 66                 |                       |                       |                       |                       |
|                                | Operation<br>Ambient<br>Temperature   | -30°C - +60°C         |                       |                       |                       |                       |
|                                | Software<br>version   | TN1.0                 |                       |                       |                       |                       |

| Model                         | MAX<br>50KTL3-<br>XL1 | MAX<br>60KTL3-<br>XL1 | MAX<br>70KTL3-<br>XL1 | MAX<br>73KTL3-<br>XL1 | MAX<br>75KTL3-<br>XL1 |
|-------------------------------|-----------------------|-----------------------|-----------------------|-----------------------|-----------------------|
| Max.PV voltage                | 1100Vdc               |                       |                       |                       |                       |
| MPPT voltage                  | 180-850Vdc            |                       |                       |                       |                       |
| Max.input current             | 10*32A                |                       |                       |                       |                       |
| PV Isc                        | 10*40A                |                       |                       |                       |                       |
| Nominal output voltage        | 3W/N/PE, 127/220Vac   |                       |                       |                       |                       |
| Nominal output Frequency      | 50/60Hz               |                       |                       |                       |                       |
| Max.output current            | 144.3A                | 173.2A                | 183.7A                | 191.6A                | 196.9A                |
| Max. output power             | 50KW                  | 60KW                  | 70KW                  | 73KW                  | 75KW                  |
| Max. apparent power           | 55KVA                 | 66KVA                 | 70KVA                 | 73KVA                 | 75KVA                 |
| Power factor range            | 0.8Leading~0.8Lagging |                       |                       |                       |                       |
| Safety level                  | Class I               |                       |                       |                       |                       |
| Ingress Protection            | IP 66                 |                       |                       |                       |                       |
| Operation Ambient Temperature | -30°C - +60°C         |                       |                       |                       |                       |
| Software version              | TN1.0                 |                       |                       |                       |                       |

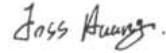
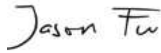
| Responsible Testing Laboratory (as applicable), testing procedure and testing location(s): |   |   |
|--|---|---|
| <input checked="" type="checkbox"/>  | <b>Testing Laboratory:</b>                          | Intertek Testing Services Shenzhen Ltd. Guangzhou Branch  |
|  | <b>Testing location/ address .....</b>              | Room 02, & 101/E201/E301/E401/E501/E601/E701/E801 of Room 01 1-8/F., No. 7-2. Caipin Road, Science City, GETDD, Guangzhou, Guangdong, China |
|  | <b>Tested by (name, function, signature) .....</b>  | Joss Huang<br>Engineer                                   |
|  | <b>Approved by (name, function, signature) ..</b>   | Jason Fu<br>Supervisor                                   |
| <hr/>  |   |   |
| <input type="checkbox"/>   | <b>Testing procedure: CTF Stage 1:</b>              | N/A   |
|  | <b>Testing location/ address .....</b>              | N/A   |
|  | <b>Tested by (name, function, signature) .....</b>  | N/A   |
|  | <b>Approved by (name, function, signature) ..</b>   | N/A   |
| <hr/>  |   |   |
| <input type="checkbox"/>   | <b>Testing procedure: CTF Stage 2:</b>              | N/A   |
|  | <b>Testing location/ address .....</b>              | N/A   |
|  | <b>Tested by (name + signature).....</b>            | N/A   |
|  | <b>Witnessed by (name, function, signature) . :</b> | N/A   |
|  | <b>Approved by (name, function, signature) .. :</b> | N/A   |
| <hr/>  |   |   |
| <input type="checkbox"/>   | <b>Testing procedure: CTF Stage 3:</b>              | N/A   |
| <input type="checkbox"/>   | <b>Testing procedure: CTF Stage 4:</b>              | N/A   |
|  | <b>Testing location/ address .....</b>              | N/A   |
|  | <b>Tested by (name, function, signature) .....</b>  | N/A   |
|  | <b>Witnessed by (name, function, signature) . :</b> | N/A   |
|  | <b>Approved by (name, function, signature) .. :</b> | N/A   |
|  | <b>Supervised by (name, function, signature) :</b>  | N/A   |

|   |   |
|---|---|
| <b>List of Attachments (including a total number of pages in each attachment):</b><br>N/A         |   |
| <b>Summary of testing:</b>  |   |
| <b>Tests performed (name of test and test clause):</b><br>All applicable tests                    | <b>Testing location:</b><br>Intertek Testing Services Shenzhen Ltd.<br>Guangzhou Branch<br>Room 02, &<br>101/E201/E301/E401/E501/E601/E701/E801 of<br>Room 01 1-8/F., No. 7-2. Caipin Road, Science<br>City, GETDD, Guangzhou, Guangdong, China |
| <b>Summary of compliance with National Differences (List of countries addressed):</b><br>N/A      |   |
| <input checked="" type="checkbox"/> <b>The product fulfils the requirements of IEC 62116:2014</b> |   |

**Copy of marking plate:**

The artwork below may be only a draft. The use of certification marks on a product must be authorized by the respective NCBS that own these marks.

| <b>GROWATT</b><br>PV Grid Inverter |                          |
|------------------------------------|--------------------------|
| Model name                         | MAX 75KTL3-XL1           |
| Max. PV voltage                    | 1100 d.c.V               |
| PV voltage range                   | 180-850 d.c.V            |
| PV I <sub>sc</sub>                 | 32 d.c.A*10              |
| Max. input current                 | 40 d.c.A*10              |
| Max. output power                  | 75 kW                    |
| Max. apparent power                | 75 kVA                   |
| Nominal output voltage             | 3W/N/PE<br>127/220 a.c.V |
| Max. output current                | 196.9 a.c.A              |
| Nominal output frequency           | 50/60 Hz                 |
| Power factor range                 | 0.8leading~0.8lagging    |
| Safety level                       | Class I                  |
| Ingress protection                 | IP66                     |
| Operation ambient temperature      | -30°C ~ +60°C            |
| VDE0126-1-1                        |                          |
|                                    |                          |
| Made in China                      |                          |

| <b>GROWATT</b><br>PV Grid Inverter |                          |
|------------------------------------|--------------------------|
| Model name                         | MAX 75KTL3-XL2           |
| Max. PV voltage                    | 1100 d.c.V               |
| PV voltage range                   | 180-850 d.c.V            |
| PV I <sub>sc</sub>                 | 56.5 d.c.A*8             |
| Max. input current                 | 45 d.c.A*8               |
| Max. output power                  | 75 kW                    |
| Max. apparent power                | 75 kVA                   |
| Nominal output voltage             | 3W/N/PE<br>127/220 a.c.V |
| Max. output current                | 196.9 a.c.A              |
| Nominal output frequency           | 50/60 Hz                 |
| Power factor range                 | 0.8leading~0.8lagging    |
| Safety level                       | Class I                  |
| Ingress protection                 | IP66                     |
| Operation ambient temperature      | -30°C ~ +60°C            |
| VDE0126-1-1                        |                          |
|                                    |                          |
| Made in China                      |                          |

**Note:**

1. The above markings are the minimum requirements required by the safety standard. For the final production samples, the additional markings which do not give rise to misunderstanding may be added.
2. Label is attached on the side surface of enclosure and visible after installation.
3. Other labels are identical to above, except the model's name and ratings

|  |  |
|--|--|
| <b>Test item particulars</b> .....:  |  |
| <b>Classification of installation and use</b> .....: Fixed and outdoor use   |  |
| <b>Supply Connection</b> .....: Permanent connection   |  |
| .....:   |  |
| <b>Possible test case verdicts:</b>  |  |
| - test case does not apply to the test object..... : N/A   |  |
| - test object does meet the requirement..... : P (Pass)  |  |
| - test object does not meet the requirement..... : F (Fail)  |  |
| <b>Testing</b> ..... :   |  |
| <b>Date of receipt of test item</b> ..... : 06 April 2022  |  |
| <b>Date (s) of performance of tests</b> ..... : 06 April 2022 to 10 May 2022   |  |
| <b>General remarks:</b>  |  |
| <p>"(See Enclosure #)" refers to additional information appended to the report.<br/>         "(See appended table)" refers to a table appended to the report.<br/> <b>Throughout this report a <input type="checkbox"/> comma / <input checked="" type="checkbox"/> point is used as the decimal separator.</b></p> <p>Determination of the test conclusion is based on IEC Guide 115 in consideration of measurement uncertainty.</p> <p>This report is for the exclusive use of Intertek's Client and is provided pursuant to the agreement between Intertek and its Client. Intertek's responsibility and liability are limited to the terms and conditions of the agreement. Intertek assumes no liability to any party, other than to the Client in accordance with the agreement, for any loss, expense or damage occasioned by the use of this report. Only the Client is authorized to permit copying or distribution of this report and then only in its entirety. Any use of the Intertek name or one of its marks for the sale or advertisement of the tested material, product or service must first be approved in writing by Intertek. The observations and test results in this report are relevant only to the sample tested. This report by itself does not imply that the material, product, or service is or has ever been under an Intertek certification program.</p> <p>The test report only allows to be revised only within the report defined retention period unless standard or regulation was withdrawn or invalid.</p> <p><b>This report shall be used together with the report 220308046GZU-001.</b></p> |  |
| <b>Manufacturer's Declaration per sub-clause 4.2.5 of IEC 62116B:</b>  |  |
| The application for obtaining a CB Test Certificate includes more than one factory location and a declaration from the Manufacturer stating that the sample(s) submitted for evaluation is (are) representative of the products from each factory has been provided ..... :  | <input type="checkbox"/> <b>Yes</b><br><input checked="" type="checkbox"/> <b>Not applicable</b> |

**When differences exist; they shall be identified in the General product information section.**

**Name and address of factory (ies) .....** : Guangdong Growatt New Energy Co., Ltd.  
Growatt Industrial Park, No.17 Pingheng Road  
Pingtan Town, Huiyang District, Huizhou,  
Guangdong, China

**General product information:**

The unit is a three-phase PV Grid inverter, it can convert the high PV voltage to Grid voltage and feed into Grid network.

The unit is providing EMC filtering at the PV side and AC side. It is transformerless between the PV circuit and AC circuit.

The unit has three controllers. The master controller DSP A measure the PV voltage and current, AFCI, PV ISO and also communicate with the slave controller B and slave controller ARM and etc; The slave controller DSP B is used to INV control and PV ISO measurement and etc.

The slave controller ARM monitor AC voltage, GFCI and communicate with the master controller DSP

The relays are designed to redundant structure that controlled by separately.

The master controller A and slave controller B are used together to control relay open or close, if the single fault on one controller, the other controller can be capable to open the relay, so that still providing safety means.

The topology diagram as following:

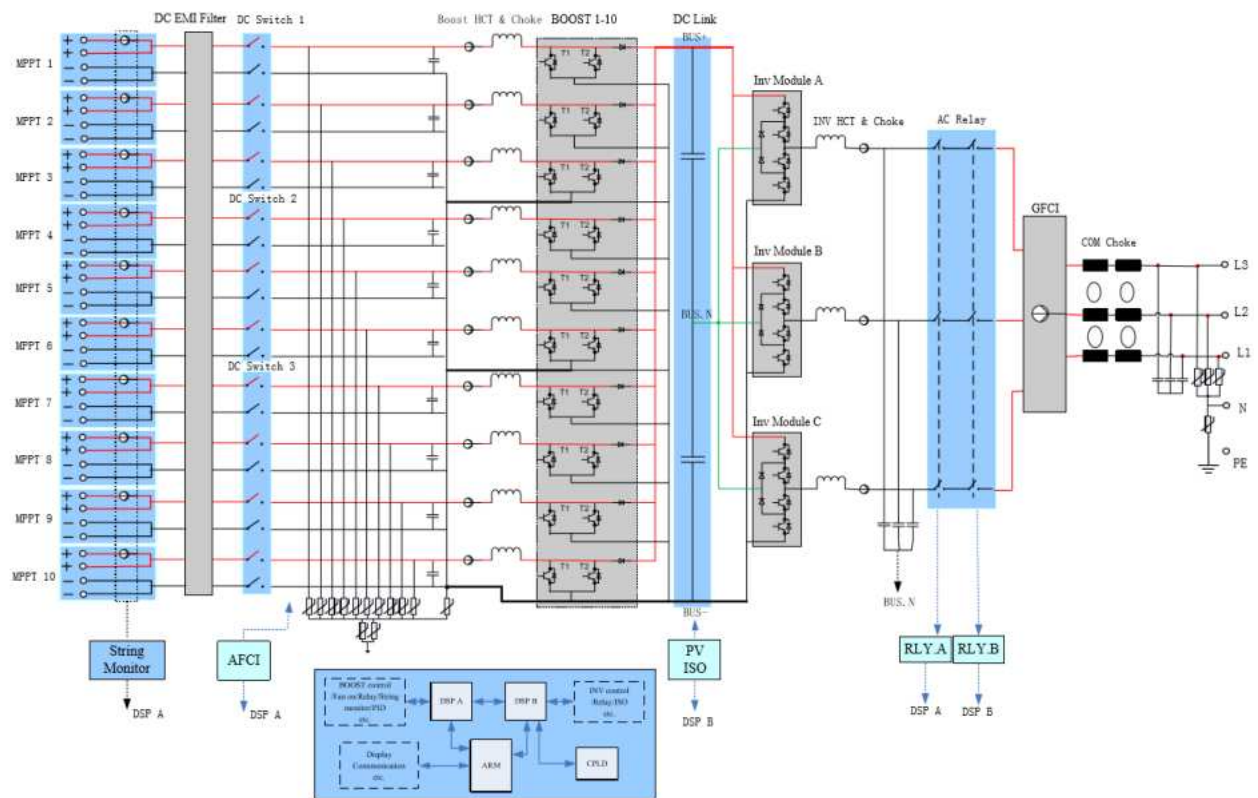

**Difference of models:**

All models are identical, except the number of MPPT and the output power derating in software.

Other than special notice, the model MAX 75KTL3-XL2 is as the representative test model in this report.

| <b>IEC 62116</b> |  |  |         |
|------------------|--|--|---------|
| Clause           | Requirement + Test   | Result - Remark  | Verdict |
| <b>4</b>         | <b>Testing circuit</b>   |  |         |
|                  | The testing circuit shown in Figure 1 is employed.   |  | P       |
|                  | Similar circuits are used for three-phase output.  |  | P       |
|                  | Parameters to be measured are shown in Table 1 and Figure 1. Parameters to be recorded in the test report are discussed in Clause 7.   |  | P       |
| <b>5</b>         | <b>Testing equipment</b>   |  |         |
| <b>5.1</b>       | <b>Measuring instruments</b>   |  |         |
|                  | The waveform measurement/capture device is able to record the waveform from the beginning of the islanding test until the EUT ceases to energize the island.   | Waveform caught from the switch open and the EUT cease to energize | P       |
|                  | For multi-phase EUT, all phases are monitored.   |  | P       |
|                  | A waveform monitor designed to detect and calculate the run-on time may be used.   |  | P       |
|                  | For multi-phase EUT, the test and measurement equipment is recorded each phase current and each phase-to-neutral or phase-to-phase voltage, as appropriate, to determine fundamental frequency active and reactive power flow over the duration of the test.   |  | P       |
|                  | A sampling rate of 10 kHz or higher is recommended. The minimum measurement accuracy is 1 % or less of rated EUT nominal output voltage and 1 % or less of rated EUT output current  |  | P       |
|                  | Current, active power, and reactive power measurements through switch S1 used to determine the circuit balance conditions report the fundamental (50 Hz or 60 Hz) component.   |  | P       |
| <b>5.2</b>       | <b>DC power source</b>   |  |         |
| <b>5.2.1</b>     | <b>General</b>   |  |         |
|                  | A PV array or PV array simulator (preferred) may be used. If the EUT can operate in utility-interconnected mode from a storage battery, a DC power source may be used in lieu of a battery as long as the DC power source is not the limiting device as far as the maximum EUT input current is concerned. | Topcon PV simulator used   | P       |
|                  | The DC power source provides voltage and current necessary to meet the testing requirements described in Clause 6.   |  | P       |
| <b>5.2.2</b>     | <b>PV array simulator</b>  |  |         |
|                  |  |  | P       |

| <b>IEC 62116</b> |   |                          |         |
|------------------|---|--------------------------|---------|
| Clause           | Requirement + Test  | Result - Remark          | Verdict |
|                  | The tests are conducted at the input voltage defined in Table 2 below, and the current is limited to 1,5 times the rated photovoltaic input current, except when specified otherwise by the test requirements.  | Topcon PV simulator used | P       |
|                  | A PV array simulator is recommended, however, any type of power source may be used if it does not influence the test results.   |                          | P       |
| <b>5.2.3</b>     | <b>Current and voltage limited DC power supply with series resistance</b>   |                          | N/A     |
|                  | A DC power source used as the EUT input source is capable of EUT maximum input power (so as to achieve EUT maximum output power) at minimum and maximum EUT input operating voltage.  |                          | N/A     |
|                  | The power source provides adjustable current and voltage limit, set to provide the desired short circuit current and open circuit voltage when combined with the series and shunt resistance described below.   |                          | N/A     |
|                  | <p>A series resistance (and, optionally, a shunt resistance) is selected to provide a fill factor within the range:</p> <p>Output power: Sufficient to provide maximum EUT output power and other levels specified by test conditions of table 5.</p> <p>Response speed: The response time of a simulator to a step in output voltage, due to a 5% load change, results in a settling of the output current to within 10% of its final value in less than 1ms.</p> <p>Stability: Excluding the variations caused by the EUT MPPT, simulator output power remains stable within 2 % of specified power level over the duration of the test: from the point where load balance is achieved until the island condition is cleared or the allowable run-on time is exceeded.</p> <p>Power factor: 0.25 to 0.8</p> |                          | N/A     |
| <b>5.2.4</b>     | <b>PV array</b>   |                          | N/A     |
|                  | A PV array used as the EUT input source is capable of EUT maximum input power at minimum and maximum EUT input operating voltage.   |                          | N/A     |

| IEC 62116                          |   |                 |            |         |                     |             |         |           |                      |                                    |                   |  |   |
|------------------------------------|---|-----------------|------------|---------|---------------------|-------------|---------|-----------|----------------------|------------------------------------|-------------------|--|---|
| Clause                             | Requirement + Test  | Result - Remark | Verdict    |         |                     |             |         |           |                      |                                    |                   |  |   |
|                                    | Testing is limited to times when the irradiance varies by no more than 2 % over the duration of the test as measured by a silicon-type pyranometer or reference device. It may be necessary to adjust the array configuration to achieve the input voltage and power levels prescribed in 6.1.  |                 | N/A        |         |                     |             |         |           |                      |                                    |                   |  |   |
| <b>5.3</b>                         | <b>AC power source</b>  |                 |            |         |                     |             |         |           |                      |                                    |                   |  |   |
|                                    | <p>The utility grid or other AC power source may be used as long as it meets the conditions specified in Table 4.</p> <p style="text-align: center;"><b>Table 4 – AC power source requirements</b></p> <table border="1" style="width: 100%; border-collapse: collapse;"> <thead> <tr> <th style="text-align: center;">Items</th> <th style="text-align: center;">Conditions</th> </tr> </thead> <tbody> <tr> <td>Voltage</td> <td>Nominal <math>\pm 2.0</math> %</td> </tr> <tr> <td>Voltage THD</td> <td>&lt; 2.5 %</td> </tr> <tr> <td>Frequency</td> <td>Nominal <math>\pm 0.1</math> Hz</td> </tr> <tr> <td>Phase angle distance <sup>1)</sup></td> <td>120 ° <math>\pm</math> 1.5 °</td> </tr> </tbody> </table> <p><small><sup>1)</sup> Three-phase case only.</small></p> | Items           | Conditions | Voltage | Nominal $\pm 2.0$ % | Voltage THD | < 2.5 % | Frequency | Nominal $\pm 0.1$ Hz | Phase angle distance <sup>1)</sup> | 120 ° $\pm$ 1.5 ° |  | P |
| Items                              | Conditions  |                 |            |         |                     |             |         |           |                      |                                    |                   |  |   |
| Voltage                            | Nominal $\pm 2.0$ %   |                 |            |         |                     |             |         |           |                      |                                    |                   |  |   |
| Voltage THD                        | < 2.5 %   |                 |            |         |                     |             |         |           |                      |                                    |                   |  |   |
| Frequency                          | Nominal $\pm 0.1$ Hz  |                 |            |         |                     |             |         |           |                      |                                    |                   |  |   |
| Phase angle distance <sup>1)</sup> | 120 ° $\pm$ 1.5 °   |                 |            |         |                     |             |         |           |                      |                                    |                   |  |   |
| <b>5.4</b>                         | <b>AC loads</b>   |                 |            |         |                     |             |         |           |                      |                                    |                   |  |   |
|                                    | On the AC side of the EUT, variable resistance, capacitance, and inductance are connected in parallel as loads between the EUT and the AC power source. Other sources of load, such as electronic loads, may be used if it can be shown that the source does not cause results that are different than would be obtained with passive resistors, inductors, and capacitors.   |                 | P          |         |                     |             |         |           |                      |                                    |                   |  |   |
|                                    | All AC loads are rated for and adjustable to all test conditions. The equations for Qf are based upon an ideal parallel RLC circuit. For this reason, non-inductive resistors, low loss (high Qf) inductors, and capacitors with low effective series resistance and effective series inductance are utilized in the test circuit. Iron core inductors, if used, are not exceed a current THD of 2 % when operated at nominal voltage. Load components are conservatively rated for the voltage and power levels expected. Resistor power ratings are chosen so as to minimize thermally-induced drift in esistance values during the course of the test.   |                 | P          |         |                     |             |         |           |                      |                                    |                   |  |   |
|                                    | Active and reactive power is calculated (using the measurements provided in Table 1) in each of the R, L and C legs of the load so that these parasitic parameters (and parasitics introduced by variacs or autotransformers) are properly accounted for when calculating Qf.   |                 | P          |         |                     |             |         |           |                      |                                    |                   |  |   |

| IEC 62116 |                    |                 |         |
|-----------|--------------------|-----------------|---------|
| Clause    | Requirement + Test | Result - Remark | Verdict |

|            |   |                             |          |
|------------|---|-----------------------------|----------|
| <b>6</b>   | <b>Test for single or multi-phase inverter</b>  |                             |          |
| <b>6.1</b> | <b>Test procedure</b>   | <b>(see appended table)</b> | <b>P</b> |
|            | The test uses an RLC load, resonant at the EUT nominal frequency (50 Hz or 60 Hz) and matched to the EUT output power.  |                             | P        |
|            | For multi-phase EUT, the load is balanced across all phases and the switch S1 as in Figure 1 opens all phases   |                             | P        |
|            | This test is performed with the EUT conditions as in Table 5, where power and voltage values are given as a percent of EUT full output rating.  |                             | P        |
|            | a) ..Determine EUT test output power  |                             | P        |
|            | b) .Adjusting the DC input source   |                             | P        |
|            | c) .Turn off the EUT and open S1  |                             | P        |
|            | d) .Adjust the RLC circuit to have $Q_f = 1.0 \pm 0.05$   |                             | P        |
|            | e) ..Connect the RLC load configured in step d) to the EUT by closing S2  |                             | P        |
|            | f) ..Open the utility-disconnect switch S1 to initiate the test, Run-on time is recorded.   |                             | P        |
|            | g) .For test condition A, adjust the real load and only one of the reactive load components to each of the load imbalance conditions shown in the shaded portion of table 6. If any of the recorded run-on times are longer than the one recorded for the rated balance condition, then the non-shaded parameter combinations also require testing. |                             | P        |
|            | h) For test condition B and C, adjust the only one reactive load components by approximately 1,0% per test, within a total range of 95% to 105% of the operating point. If run-on times are still increasing at the 95% or 105% points, additional 1% increments have to be taken until run-on times begin decreasing.                              |                             | P        |
| <b>6.2</b> | <b>Pass/fail criteria</b>   |                             |          |
|            | An EUT is considered to comply with the requirements for islanding protection when each case of recorded run-on time is less than 2 s or meets the requirements of local codes.   |                             | P        |
| <b>7</b>   | <b>Documentation</b>  |                             |          |
|            | At a minimum, the following information is recorded and maintained in the test report.  |                             | P        |
|            | a) Specifications of EUT. Table 8 provides an example of the type of information that is provided.  |                             | P        |

| IEC 62116 |  |                 |         |
|-----------|--|-----------------|---------|
| Clause    | Requirement + Test   | Result - Remark | Verdict |
|           | b) Measurement results. Table 9 provides an example of the type of information that is provided. Actual measured values is to be recorded. |                 | P       |
|           | c) Block diagram of test circuit.  |                 | P       |
|           | d) Specifications of the test and measurement equipment. Table 10 provides an example of the type of information that is provided.         |                 | P       |
|           | e) Any test configuration or procedure details such as methods of achieving specified load and EUT output conditions.                      |                 | P       |
|           | f) Any additional information required by the testing laboratory's accreditation.  |                 | P       |
|           | g) Specify the evaluation criterion from clause 6.2 that was utilized to determine if the product passed or failed the test.               |                 | P       |
| Annex A   | Islanding as it applies to PV systems(Informative)   |                 | --      |
| A.1       | General  |                 | --      |
| A.2       | Impact of distortion on islanding  |                 | --      |
| Annex B   | Test for independent islanding detection device (relay)(Informative)   |                 | --      |
| B.1       | Introduction   |                 | --      |
| B.2       | Testing circuit  |                 | --      |
| B.3       | Testing equipment  |                 | --      |
| B.4       | Testing procedure  |                 | --      |
| B.5       | Documentation  |                 | --      |

| IEC 62116 |                    |                 |         |
|-----------|--------------------|-----------------|---------|
| Clause    | Requirement + Test | Result - Remark | Verdict |

| 6   | TABLE: tested condition and run-on time |                             |                 |                 |                 |                       |                             |                     |  | P |
|---|---|-----------------------------|-----------------|-----------------|-----------------|-----------------------|-----------------------------|---------------------|--|---|
| Model: Tested on model MAX 75KTL3-XL2 with frequency 50Hz |   |                             |                 |                 |                 |                       |                             |                     |  |   |
| No.   | P <sub>EUT</sub> (% of EUT rating)      | Reactive load (% of normal) | P <sub>AC</sub> | Q <sub>AC</sub> | Run-on time(ms) | P <sub>EUT</sub> (KW) | Actual Q <sub>f</sub> (Var) | V <sub>DC</sub> (V) | Which load is selected to be adjusted (R or L) |   |
| Test condition A  |   |                             |                 |                 |                 |                       |                             |                     |  |   |
| 1   | 100                                     | 100                         | 0               | 0               | 459.5           | 75.11                 | 1.00                        | 800                 | /  |   |
| 2   | 100                                     | 100                         | -5              | -5              | 332.5           | 75.11                 | 0.98                        | 800                 | /  |   |
| 3   | 100                                     | 100                         | -5              | 0               | 279.5           | 75.11                 | 0.95                        | 800                 | /  |   |
| 4   | 100                                     | 100                         | -5              | +5              | 305.0           | 75.11                 | 0.93                        | 800                 | /  |   |
| 5   | 100                                     | 100                         | 0               | -5              | 401.0           | 75.11                 | 1.03                        | 800                 | /  |   |
| 6   | 100                                     | 100                         | 0               | +5              | 311.5           | 75.11                 | 0.98                        | 800                 | /  |   |
| 7   | 100                                     | 100                         | +5              | -5              | 258.5           | 75.11                 | 1.08                        | 800                 | /  |   |
| 8   | 100                                     | 100                         | +5              | 0               | 279.5           | 75.11                 | 1.06                        | 800                 | /  |   |
| 9   | 100                                     | 100                         | +5              | +5              | 157.5           | 75.11                 | 1.03                        | 800                 | /  |   |
| Test condition B  |   |                             |                 |                 |                 |                       |                             |                     |  |   |
| 10  | 66                                      | 66                          | 0               | 0               | 299.5           | 49.68                 | 1.00                        | 520                 | /  |   |
| 11  | 66                                      | 66                          | 0               | -5              | 196.0           | 49.68                 | 1.03                        | 520                 | L  |   |
| 12  | 66                                      | 66                          | 0               | -4              | 292.0           | 49.68                 | 1.02                        | 520                 | L  |   |
| 13  | 66                                      | 66                          | 0               | -3              | 287.5           | 49.68                 | 1.02                        | 520                 | L  |   |
| 14  | 66                                      | 66                          | 0               | -2              | 243.5           | 49.68                 | 1.01                        | 520                 | L  |   |
| 15  | 66                                      | 66                          | 0               | -1              | 242.0           | 49.68                 | 1.01                        | 520                 | L  |   |
| 16  | 66                                      | 66                          | 0               | 1               | 308.0           | 49.68                 | 0.99                        | 520                 | L  |   |
| 17  | 66                                      | 66                          | 0               | 2               | 464.0           | 49.68                 | 0.99                        | 520                 | L  |   |
| 18  | 66                                      | 66                          | 0               | 3               | 415.5           | 49.68                 | 0.98                        | 520                 | L  |   |
| 19  | 66                                      | 66                          | 0               | 4               | 409.5           | 49.68                 | 0.98                        | 520                 | L  |   |
| 20  | 66                                      | 66                          | 0               | 5               | 311.5           | 49.68                 | 0.97                        | 520                 | L  |   |
| Test condition C  |   |                             |                 |                 |                 |                       |                             |                     |  |   |
| 21  | 33                                      | 33                          | 0               | 0               | 838.0           | 24.81                 | 1.00                        | 309                 | /  |   |
| 22  | 33                                      | 33                          | 0               | -5              | 529.0           | 24.81                 | 1.03                        | 309                 | L  |   |
| 23  | 33                                      | 33                          | 0               | -4              | 668.0           | 24.81                 | 1.02                        | 309                 | L  |   |
| 24  | 33                                      | 33                          | 0               | -3              | 832.0           | 24.81                 | 1.02                        | 309                 | L  |   |
| 25  | 33                                      | 33                          | 0               | -2              | 652.0           | 24.81                 | 1.01                        | 309                 | L  |   |
| 26  | 33                                      | 33                          | 0               | -1              | 770.0           | 24.81                 | 1.01                        | 309                 | L  |   |
| 27  | 33                                      | 33                          | 0               | 1               | 716.0           | 24.81                 | 0.99                        | 309                 | L  |   |
| 28  | 33                                      | 33                          | 0               | 2               | 600.0           | 24.81                 | 0.99                        | 309                 | L  |   |
| 29  | 33                                      | 33                          | 0               | 3               | 858.0           | 24.81                 | 0.98                        | 309                 | L  |   |
| 30  | 33                                      | 33                          | 0               | 4               | 612.0           | 24.81                 | 0.98                        | 309                 | L  |   |
| 31  | 33                                      | 33                          | 0               | 5               | 460.0           | 24.81                 | 0.97                        | 309                 | L  |   |

| IEC 62116 |                    |                 |         |
|-----------|--------------------|-----------------|---------|
| Clause    | Requirement + Test | Result - Remark | Verdict |

Supplementary information:

For test condition A:

If any of the recorded run-on times are longer than the one recorded for the rated balance condition, then the non-shaded parameter combinations also require testing.

For test condition B and C:

If run-on times are still increasing at the 95 % or 105 % points, additional 1 % increments is taken until run-on times begin decreasing.

| IEC 62116 |                    |                 |         |
|-----------|--------------------|-----------------|---------|
| Clause    | Requirement + Test | Result - Remark | Verdict |

| 6   | TABLE: tested condition and run-on time |                             |                 |                 |                 |                       |                             |                     |  | P |
|---|---|-----------------------------|-----------------|-----------------|-----------------|-----------------------|-----------------------------|---------------------|--|---|
| Model: Tested on model MAX 75KTL3-XL2 with frequency 60Hz |   |                             |                 |                 |                 |                       |                             |                     |  |   |
| No.   | P <sub>EUT</sub> (% of EUT rating)      | Reactive load (% of normal) | P <sub>AC</sub> | Q <sub>AC</sub> | Run-on time(ms) | P <sub>EUT</sub> (KW) | Actual Q <sub>f</sub> (Var) | V <sub>DC</sub> (V) | Which load is selected to be adjusted (R or L) |   |
| Test condition A  |   |                             |                 |                 |                 |                       |                             |                     |  |   |
| 1   | 100                                     | 100                         | 0               | 0               | 730.0           | 75.11                 | 1.00                        | 800                 | /  |   |
| 2   | 100                                     | 100                         | -5              | -5              | 330.0           | 75.11                 | 0.97                        | 800                 | /  |   |
| 3   | 100                                     | 100                         | -5              | 0               | 484.0           | 75.11                 | 0.95                        | 800                 | /  |   |
| 4   | 100                                     | 100                         | -5              | +5              | 414.0           | 75.11                 | 0.93                        | 800                 | /  |   |
| 5   | 100                                     | 100                         | 0               | -5              | 322.0           | 75.11                 | 1.03                        | 800                 | /  |   |
| 6   | 100                                     | 100                         | 0               | +5              | 256.0           | 75.11                 | 0.98                        | 800                 | /  |   |
| 7   | 100                                     | 100                         | +5              | -5              | 260.0           | 75.11                 | 1.08                        | 800                 | /  |   |
| 8   | 100                                     | 100                         | +5              | 0               | 648.0           | 75.11                 | 1.06                        | 800                 | /  |   |
| 9   | 100                                     | 100                         | +5              | +5              | 588.0           | 75.11                 | 1.04                        | 800                 | /  |   |
| Test condition B  |   |                             |                 |                 |                 |                       |                             |                     |  |   |
| 10  | 66                                      | 66                          | 0               | 0               | 335.5           | 49.68                 | 1.00                        | 520                 | /  |   |
| 11  | 66                                      | 66                          | 0               | -5              | 259.0           | 49.68                 | 1.03                        | 520                 | L  |   |
| 12  | 66                                      | 66                          | 0               | -4              | 327.0           | 49.68                 | 1.02                        | 520                 | L  |   |
| 13  | 66                                      | 66                          | 0               | -3              | 373.5           | 49.68                 | 1.02                        | 520                 | L  |   |
| 14  | 66                                      | 66                          | 0               | -2              | 327.5           | 49.68                 | 1.01                        | 520                 | L  |   |
| 15  | 66                                      | 66                          | 0               | -1              | 285.5           | 49.68                 | 1.01                        | 520                 | L  |   |
| 16  | 66                                      | 66                          | 0               | 1               | 313.0           | 49.68                 | 0.99                        | 520                 | L  |   |
| 17  | 66                                      | 66                          | 0               | 2               | 629.0           | 49.68                 | 0.99                        | 520                 | L  |   |
| 18  | 66                                      | 66                          | 0               | 3               | 327.0           | 49.68                 | 0.98                        | 520                 | L  |   |
| 19  | 66                                      | 66                          | 0               | 4               | 411.0           | 49.68                 | 0.98                        | 520                 | L  |   |
| 20  | 66                                      | 66                          | 0               | 5               | 299.0           | 49.68                 | 0.97                        | 520                 | L  |   |
| Test condition C  |   |                             |                 |                 |                 |                       |                             |                     |  |   |
| 21  | 33                                      | 33                          | 0               | 0               | 530.0           | 24.81                 | 1.00                        | 309                 | /  |   |
| 22  | 33                                      | 33                          | 0               | -5              | 134.5           | 24.81                 | 1.03                        | 309                 | L  |   |
| 23  | 33                                      | 33                          | 0               | -4              | 192.5           | 24.81                 | 1.02                        | 309                 | L  |   |
| 24  | 33                                      | 33                          | 0               | -3              | 178.5           | 24.81                 | 1.02                        | 309                 | L  |   |
| 25  | 33                                      | 33                          | 0               | -2              | 226.5           | 24.81                 | 1.01                        | 309                 | L  |   |
| 26  | 33                                      | 33                          | 0               | -1              | 234.5           | 24.81                 | 1.01                        | 309                 | L  |   |
| 27  | 33                                      | 33                          | 0               | 1               | 235.5           | 24.81                 | 0.99                        | 309                 | L  |   |
| 28  | 33                                      | 33                          | 0               | 2               | 153.5           | 24.81                 | 0.99                        | 309                 | L  |   |
| 29  | 33                                      | 33                          | 0               | 3               | 182.5           | 24.81                 | 0.98                        | 309                 | L  |   |
| 30  | 33                                      | 33                          | 0               | 4               | 176.5           | 24.81                 | 0.98                        | 309                 | L  |   |
| 31  | 33                                      | 33                          | 0               | 5               | 175.5           | 24.81                 | 0.97                        | 309                 | L  |   |

| IEC 62116 |                    |                 |         |
|-----------|--------------------|-----------------|---------|
| Clause    | Requirement + Test | Result - Remark | Verdict |

Supplementary information:

For test condition A:

If any of the recorded run-on times are longer than the one recorded for the rated balance condition, then the non-shaded parameter combinations also require testing.

For test condition B and C:

If run-on times are still increasing at the 95 % or 105 % points, additional 1 % increments is taken until run-on times begin decreasing.

--- End of test report---

# Certificate of Conformity

Certificate Number: CN-PV-220113

On the basis of the tests undertaken, the samples of the below product have been found to comply with the requirements of the referenced specifications /standards at the time the tests were carried out. It does not imply that Intertek has performed any surveillance or control of the manufacture. The manufacturer shall ensure that the manufacturing process assures compliance of the production units with the examined products mentioned in this certificate.

|   |   |
|---|---|
| <b>Applicant:</b>                                     | Shenzhen Growatt New Energy Co., Ltd.<br>4-13/F, Building A, Sino-German (Europe) Industrial Park, Hangcheng Ave, Bao'an District, Shenzhen, China  |
| <b>Product:</b>                                       | PV Grid inverter  |
| <b>Ratings &amp; Principle Characteristics:</b>       | See Appendix to Certificate of Conformity   |
| <b>Model:</b>   | MAX 50KTL3-XL2, MAX 60KTL3-XL2, MAX 70KTL3-XL2, MAX 73KTL3-XL2<br>MAX 75KTL3-XL2, MAX 50KTL3-XL1, MAX 60KTL3-XL1, MAX 70KTL3-XL1,<br>MAX 73KTL3-XL1, MAX 75KTL3-XL1   |
| <b>Brand Name&lt;s&gt;:</b>                           | GROWATT   |
| <b>Product Complies with:</b>                         | IEC 61727:2004. Photovoltaic (PV) systems – Characteristics of the utility interface<br>IEC 62116:2014. Test procedure of islanding prevention measures for utility-interconnected photovoltaic inverters   |
| <b>Certificate Issuing Office Name &amp; Address:</b> | Intertek Testing Services Ltd. Shanghai<br>West Area, 2nd Floor, No. 707, Zhangyang Road<br>China (Shanghai) Pilot Free Trade Zone, Shanghai, P. R. China<br><br>Accredited by China National Accreditation Service for Conformity Assessment (CNAS C058-P) in accordance with ISO/IEC 17065:2012 |
| <b>Test Report No.&lt;s&gt;:</b>                      | 220308046GZU-001, 220308046GZU-002  |

Certification procedure: SMS-PV-OP-19  
Product certification scheme type: Type test  
Additional information in Appendix.



Signature

Certification Manager: Grady Ye

Date: 1 June 2022



中国认可  
国际互认  
产品  
PRODUCT  
CNAS C058-P

## APPENDIX: Certificate of Conformity

This is an Appendix to Certificate of Conformity Number: CN-PV-220113

| Model                         | MAX 50KTL3-<br>XL2    | MAX 60KTL3-<br>XL2 | MAX 70KTL3-<br>XL2 | MAX 73KTL3-<br>XL2 | MAX 75KTL3-<br>XL2 |
|-------------------------------|-----------------------|--------------------|--------------------|--------------------|--------------------|
| Max.PV voltage                | 1100Vdc               |                    |                    |                    |                    |
| MPPT voltage                  | 180-850Vdc            |                    |                    |                    |                    |
| Max.input current             | 8*45A                 |                    |                    |                    |                    |
| PV Isc                        | 8*56.5A               |                    |                    |                    |                    |
| Nominal output voltage        | 3W/N/PE, 127/220Vac   |                    |                    |                    |                    |
| Nominal output Frequency      | 50/60Hz               |                    |                    |                    |                    |
| Max.output current            | 144.3A                | 173.2A             | 183.7A             | 191.6A             | 196.9A             |
| Max. output power             | 50KW                  | 60KW               | 70KW               | 73KW               | 75KW               |
| Max. apparent power           | 55KVA                 | 66KVA              | 70KVA              | 73KVA              | 75KVA              |
| Power factor range            | 0.8Leading~0.8Lagging |                    |                    |                    |                    |
| Safety level                  | Class I               |                    |                    |                    |                    |
| Ingress Protection            | IP 66                 |                    |                    |                    |                    |
| Operation Ambient Temperature | -30°C - +60°C         |                    |                    |                    |                    |
| Software version              | TN1.0                 |                    |                    |                    |                    |

This Certificate is for the exclusive use of Intertek's client and is provided pursuant to the agreement between Intertek and its Client. Intertek's responsibility and liability are limited to the terms and conditions of the agreement. Intertek assumes no liability to any party, other than to the Client in accordance with the agreement, for any loss, expense or damage occasioned by the use of this Certificate. Only the Client is authorized to permit copying or distribution of this Certificate. Any use of the Intertek name or one of its marks for the sale or advertisement of the tested material, product or service must first be approved in writing by Intertek.

## APPENDIX: Certificate of Conformity

This is an Appendix to Certificate of Conformity Number: CN-PV-220113

| Model                         | MAX 50KTL3-<br>XL1    | MAX 60KTL3-<br>XL1 | MAX 70KTL3-<br>XL1 | MAX 73KTL3-<br>XL1 | MAX 75KTL3-<br>XL1 |
|-------------------------------|-----------------------|--------------------|--------------------|--------------------|--------------------|
| Max.PV voltage                | 1100Vdc               |                    |                    |                    |                    |
| MPPT voltage                  | 180-850Vdc            |                    |                    |                    |                    |
| Max.input current             | 10*32A                |                    |                    |                    |                    |
| PV Isc                        | 10*40A                |                    |                    |                    |                    |
| Nominal output voltage        | 3W/N/PE, 127/220Vac   |                    |                    |                    |                    |
| Nominal output Frequency      | 50/60Hz               |                    |                    |                    |                    |
| Max.output current            | 144.3A                | 173.2A             | 183.7A             | 191.6A             | 196.9A             |
| Max. output power             | 50KW                  | 60KW               | 70KW               | 73KW               | 75KW               |
| Max. apparent power           | 55KVA                 | 66KVA              | 70KVA              | 73KVA              | 75KVA              |
| Power factor range            | 0.8Leading~0.8Lagging |                    |                    |                    |                    |
| Safety level                  | Class I               |                    |                    |                    |                    |
| Ingress Protection            | IP 66                 |                    |                    |                    |                    |
| Operation Ambient Temperature | -30°C - +60°C         |                    |                    |                    |                    |
| Software version              | TN1.0                 |                    |                    |                    |                    |

This Certificate is for the exclusive use of Intertek's client and is provided pursuant to the agreement between Intertek and its Client. Intertek's responsibility and liability are limited to the terms and conditions of the agreement. Intertek assumes no liability to any party, other than to the Client in accordance with the agreement, for any loss, expense or damage occasioned by the use of this Certificate. Only the Client is authorized to permit copying or distribution of this Certificate. Any use of the Intertek name or one of its marks for the sale or advertisement of the tested material, product or service must first be approved in writing by Intertek.



TL-395

Test Report issued under the responsibility of:



TEST REPORT
IEC 61727
Photovoltaic (PV) systems –
Characteristics of the utility interface

Report Number..... : 220308046GZU-001
Date of issue..... : 30 May 2022
Total number of pages ..... 26 Pages

Name of Testing Laboratory preparing the Report ..... Intertek Testing Services Shenzhen Ltd. Guangzhou Branch
Room 02, & 101/E201/E301/E401/E501/E601/E701/E801 of
Room 01 1-8/F., No. 7-2. Caipin Road, Science City, GETDD,
Guangzhou, Guangdong, China

Applicant's name ..... Shenzhen Growatt New Energy Co., Ltd.
Address..... 4-13/F, Building A, Sino-German (Europe) Industrial Park,
Hangcheng Ave, Bao'an District, Shenzhen, China

Test specification:
Standard ..... : IEC 61727:2004
Test procedure ..... : Type approval
Non-standard test method ..... : N/A

Test Report Form No. .... : IEC61727B
Test Report Form(s) Originator .... : TÜV SÜD Product Service GmbH
Master TRF ..... : Dated 2017-11-03

Copyright © 2017 IEC System of Conformity Assessment Schemes for Electrotechnical
Equipment and Components (IECEE System). All rights reserved.

This publication may be reproduced in whole or in part for non-commercial purposes as long as the IECEE is acknowledged as
copyright owner and source of the material. IECEE takes no responsibility for and will not assume liability for damages resulting
from the reader's interpretation of the reproduced material due to its placement and context.

If this Test Report Form is used by non-IECEE members, the IECEE/IEC logo and the reference to the
CB Scheme procedure shall be removed.

This report is not valid as a CB Test Report unless signed by an approved CB Testing Laboratory
and appended to a CB Test Certificate issued by an NCB in accordance with IECEE 02.

General disclaimer:

The test results presented in this report relate only to the object tested.
This report shall not be reproduced, except in full, without the written approval of the Issuing CB Testing
Laboratory. The authenticity of this Test Report and its contents can be verified by contacting the NCB,
responsible for this Test Report.

|                                |   |                       |                       |                       |                       |                       |
|--------------------------------|---|-----------------------|-----------------------|-----------------------|-----------------------|-----------------------|
| <b>Test item description :</b> | PV Grid inverter  |                       |                       |                       |                       |                       |
| <b>Trade Mark .....</b>        | GROWATT   |                       |                       |                       |                       |                       |
| <b>Manufacturer.....</b>       | Same as applicant   |                       |                       |                       |                       |                       |
| <b>Model/Type reference :</b>  | MAX 50KTL3-XL2, MAX 60KTL3-XL2, MAX 70KTL3-XL2, MAX 73KTL3-XL2<br>MAX 75KTL3-XL2, MAX 50KTL3-XL1, MAX 60KTL3-XL1, MAX 70KTL3-XL1,<br>MAX 73KTL3-XL1, MAX 75KTL3-XL1 |                       |                       |                       |                       |                       |
| <b>Ratings .....</b>           | Model   | MAX<br>50KTL3-<br>XL2 | MAX<br>60KTL3-<br>XL2 | MAX<br>70KTL3-<br>XL2 | MAX<br>73KTL3-<br>XL2 | MAX<br>75KTL3-<br>XL2 |
|                                | Max.PV<br>voltage   | 1100Vdc               |                       |                       |                       |                       |
|                                | MPPT<br>voltage   | 180-850Vdc            |                       |                       |                       |                       |
|                                | Max.input<br>current  | 8*45A                 |                       |                       |                       |                       |
|                                | PV Isc  | 8*56.5A               |                       |                       |                       |                       |
|                                | Nominal<br>output<br>voltage  | 3W/N/PE, 127/220Vac   |                       |                       |                       |                       |
|                                | Nominal<br>output<br>Frequency  | 50/60Hz               |                       |                       |                       |                       |
|                                | Max.output<br>current   | 144.3A                | 173.2A                | 183.7A                | 191.6A                | 196.9A                |
|                                | Max. output<br>power  | 50KW                  | 60KW                  | 70KW                  | 73KW                  | 75KW                  |
|                                | Max.<br>apparent<br>power   | 55KVA                 | 66KVA                 | 70KVA                 | 73KVA                 | 75KVA                 |
|                                | Power factor<br>range   | 0.8Leading~0.8Lagging |                       |                       |                       |                       |
|                                | Safety level  | Class I               |                       |                       |                       |                       |
|                                | Ingress<br>Protection   | IP 66                 |                       |                       |                       |                       |
|                                | Operation<br>Ambient<br>Temperature   | -30°C - +60°C         |                       |                       |                       |                       |
|                                | Software<br>version   | TN1.0                 |                       |                       |                       |                       |
|                                | Model   | MAX<br>50KTL3-<br>XL1 | MAX<br>60KTL3-<br>XL1 | MAX<br>70KTL3-<br>XL1 | MAX<br>73KTL3-<br>XL1 | MAX<br>75KTL3-<br>XL1 |

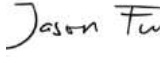

|                               |                       |        |        |        |        |
|-------------------------------|-----------------------|--------|--------|--------|--------|
| Max.PV voltage                | 1100Vdc               |        |        |        |        |
| MPPT voltage                  | 180-850Vdc            |        |        |        |        |
| Max.input current             | 10*32A                |        |        |        |        |
| PV Isc                        | 10*40A                |        |        |        |        |
| Nominal output voltage        | 3W/N/PE, 127/220Vac   |        |        |        |        |
| Nominal output Frequency      | 50/60Hz               |        |        |        |        |
| Max.output current            | 144.3A                | 173.2A | 183.7A | 191.6A | 196.9A |
| Max. output power             | 50KW                  | 60KW   | 70KW   | 73KW   | 75KW   |
| Max. apparent power           | 55KVA                 | 66KVA  | 70KVA  | 73KVA  | 75KVA  |
| Power factor range            | 0.8Leading~0.8Lagging |        |        |        |        |
| Safety level                  | Class I               |        |        |        |        |
| Ingress Protection            | IP 66                 |        |        |        |        |
| Operation Ambient Temperature | -30°C - +60°C         |        |        |        |        |
| Software version              | TN1.0                 |        |        |        |        |

|   |   |   |
|---|---|---|
| <b>Responsible Testing Laboratory (as applicable), testing procedure and testing location(s):</b> |   |   |
| <input checked="" type="checkbox"/>   | <b>Testing Laboratory:</b>                          | Intertek Testing Services Shenzhen Ltd. Guangzhou Branch  |
| <b>Testing location/ address.....:</b>  |   | Room 02, & 101/E201/E301/E401/E501/E601/E701/E801 of Room 01 1-8/F., No. 7-2. Caipin Road, Science City, GETDD, Guangzhou, Guangdong, China |
| <input type="checkbox"/>  | <b>Associated CB Testing Laboratory:</b>            | N/A   |
| <b>Testing location/ address.....:</b>  |   | N/A   |
| <b>Tested by (name, function, signature).....:</b>  |   | Joss Huang<br>Engineer<br>                               |
| <b>Approved by (name, function, signature)....:</b>   |   | Jason Fu<br>Supervisor<br>                               |
| <hr/>   |   |   |
| <input type="checkbox"/>  | <b>Testing procedure: TMP/CTF Stage 1:</b>          | N/A   |
| <b>Testing location/ address.....:</b>  |   | N/A   |
| <b>Tested by (name, function, signature).....:</b>  |   | N/A   |
| <b>Approved by (name, function, signature)....:</b>   |   | N/A   |
| <hr/>   |   |   |
| <input type="checkbox"/>  | <b>Testing procedure: WMT/CTF Stage 2:</b>          | N/A   |
| <b>Testing location/ address.....:</b>  |   | N/A   |
| <b>Tested by (name + signature) .....</b>   |   | N/A   |
| <b>Witnessed by (name, function, signature) .:</b>  |   | N/A   |
| <b>Approved by (name, function, signature)....:</b>   |   | N/A   |
| <hr/>   |   |   |
| <input type="checkbox"/>  | <b>Testing procedure:<br/>SMT/CTF Stage 3 or 4:</b> | N/A   |
| <b>Testing location/ address.....:</b>  |   | N/A   |
| <b>Tested by (name, function, signature).....:</b>  |   | N/A   |
| <b>Witnessed by (name, function, signature) .:</b>  |   | N/A   |
| <b>Approved by (name, function, signature)....:</b>   |   | N/A   |
| <b>Supervised by (name, function, signature) :</b>  |   | N/A   |

|   |   |
|---|---|
| <b>List of Attachments (including a total number of pages in each attachment):</b><br><b>Appendix 1: photos (3 pages)</b> |   |
| <b>Summary of testing:</b>  |   |
| <b>Tests performed (name of test and test clause):</b><br>All applicable tests  | <b>Testing location:</b><br>Intertek Testing Services Shenzhen Ltd.<br>Guangzhou Branch<br>Room 02, &<br>101/E201/E301/E401/E501/E601/E701/E801 of<br>Room 01 1-8/F., No. 7-2. Caipin Road, Science<br>City, GETDD, Guangzhou, Guangdong, China |
| <b>Summary of compliance with National Differences:</b><br><b>List of countries addressed</b><br>N/A                      |   |
| <input checked="" type="checkbox"/> <b>The product fulfils the requirements of IEC 61727:2004</b>                         |   |

**Copy of marking plate:**

The artwork below may be only a draft. The use of certification marks on a product must be authorized by the respective NCBs that own these marks.

| <b>GROWATT</b><br>PV Grid Inverter  |                          | <b>GROWATT</b><br>PV Grid Inverter   |                          |
|---|--------------------------|--|--------------------------|
| <b>Model name</b>   | MAX 75KTL3-XL1           | <b>Model name</b>  | MAX 75KTL3-XL2           |
| <b>Max. PV voltage</b>  | 1100 d.c.V               | <b>Max. PV voltage</b>   | 1100 d.c.V               |
| <b>PV voltage range</b>   | 180-850 d.c.V            | <b>PV voltage range</b>  | 180-850 d.c.V            |
| <b>PV Isc</b>   | 32 d.c.A*10              | <b>PV Isc</b>  | 56.5 d.c.A*8             |
| <b>Max. input current</b>   | 40 d.c.A*10              | <b>Max. input current</b>  | 45 d.c.A*8               |
| <b>Max. output power</b>  | 75 kW                    | <b>Max. output power</b>   | 75 kW                    |
| <b>Max. apparent power</b>  | 75 kVA                   | <b>Max. apparent power</b>   | 75 kVA                   |
| <b>Nominal output voltage</b>   | 3W/N/PE<br>127/220 a.c.V | <b>Nominal output voltage</b>  | 3W/N/PE<br>127/220 a.c.V |
| <b>Max. output current</b>  | 196.9 a.c.A              | <b>Max. output current</b>   | 196.9 a.c.A              |
| <b>Nominal output frequency</b>   | 50/60 Hz                 | <b>Nominal output frequency</b>  | 50/60 Hz                 |
| <b>Power factor range</b>   | 0.8leading~0.8lagging    | <b>Power factor range</b>  | 0.8leading~0.8lagging    |
| <b>Safety level</b>   | Class I                  | <b>Safety level</b>  | Class I                  |
| <b>Ingress protection</b>   | IP66                     | <b>Ingress protection</b>  | IP66                     |
| <b>Operation ambient temperature</b>  | -30°C ~ +60°C            | <b>Operation ambient temperature</b>   | -30°C ~ +60°C            |
| VDE0126-1-1<br><br>Made in China |                          | VDE0126-1-1<br><br>Made in China |                          |

**Note:**

1. The above markings are the minimum requirements required by the safety standard. For the final production samples, the additional markings which do not give rise to misunderstanding may be added.
2. Label is attached on the side surface of enclosure and visible after installation.
3. Other labels are identical to above, except the model's name and ratings

|  |  |
|--|--|
| <b>Test item particulars</b> .....:  |  |
| <b>Classification of installation and use</b> .....: Fixed and outdoor use   |  |
| <b>Supply Connection</b> .....: Permanent connection   |  |
| .....:   |  |
| <b>Possible test case verdicts:</b>  |  |
| - test case does not apply to the test object..... : N/A   |  |
| - test object does meet the requirement..... : P (Pass)  |  |
| - test object does not meet the requirement..... : F (Fail)  |  |
| <b>Testing</b> ..... :   |  |
| <b>Date of receipt of test item</b> ..... : 06 April 2022  |  |
| <b>Date (s) of performance of tests</b> ..... : 06 April 2022 to 10 May 2022   |  |
| <b>General remarks:</b>  |  |
| <p>"(See Enclosure #)" refers to additional information appended to the report.<br/>         "(See appended table)" refers to a table appended to the report.<br/> <b>Throughout this report a <input type="checkbox"/> comma / <input checked="" type="checkbox"/> point is used as the decimal separator.</b><br/>         Determination of the test conclusion is based on IEC Guide 115 in consideration of measurement uncertainty.<br/>         This report is for the exclusive use of Intertek's Client and is provided pursuant to the agreement between Intertek and its Client. Intertek's responsibility and liability are limited to the terms and conditions of the agreement. Intertek assumes no liability to any party, other than to the Client in accordance with the agreement, for any loss, expense or damage occasioned by the use of this report. Only the Client is authorized to permit copying or distribution of this report and then only in its entirety. Any use of the Intertek name or one of its marks for the sale or advertisement of the tested material, product or service must first be approved in writing by Intertek. The observations and test results in this report are relevant only to the sample tested. This report by itself does not imply that the material, product, or service is or has ever been under an Intertek certification program.<br/>         The test report only allows to be revised only within the report defined retention period unless standard or regulation was withdrawn or invalid.<br/> <b>This report shall be used together with the report 220308046GZU-002.</b></p> |  |
| <b>Manufacturer's Declaration per sub-clause 4.2.5 of IEC 61727:</b>   |  |
| The application for obtaining a CB Test Certificate includes more than one factory location and a declaration from the Manufacturer stating that the sample(s) submitted for evaluation is (are) representative of the products from each factory has been provided ..... :  | <input type="checkbox"/> <b>Yes</b><br><input checked="" type="checkbox"/> <b>Not applicable</b> |
| <b>When differences exist; they shall be identified in the General product information section.</b>  |  |
| <b>Name and address of factory (ies)</b> ..... : Guangdong Growatt New Energy Co., Ltd.<br>Growatt Industrial Park, No.17 Pingheng Road<br>Pingtan Town, Huiyang District, Huizhou, Guangdong, China   |  |

**General product information:**

The unit is a three-phase PV Grid inverter, it can convert the high PV voltage to Grid voltage and feed into Grid network.

The unit is providing EMC filtering at the PV side and AC side. It is transformerless between the PV circuit and AC circuit.

The unit has three controllers. The master controller DSP A measure the PV voltage and current, AFCI, PV ISO and also communicate with the slave controller B and slave controller ARM and etc; The slave controller DSP B is used to INV control and PV ISO measurement and etc.

The slave controller ARM monitor AC voltage, GFCI and communicate with the master controller DSP

The relays are designed to redundant structure that controlled by separately.

The master controller A and slave controller B are used together to control relay open or close, if the single fault on one controller, the other controller can be capable to open the relay, so that still providing safety means.

The topology diagram as following:

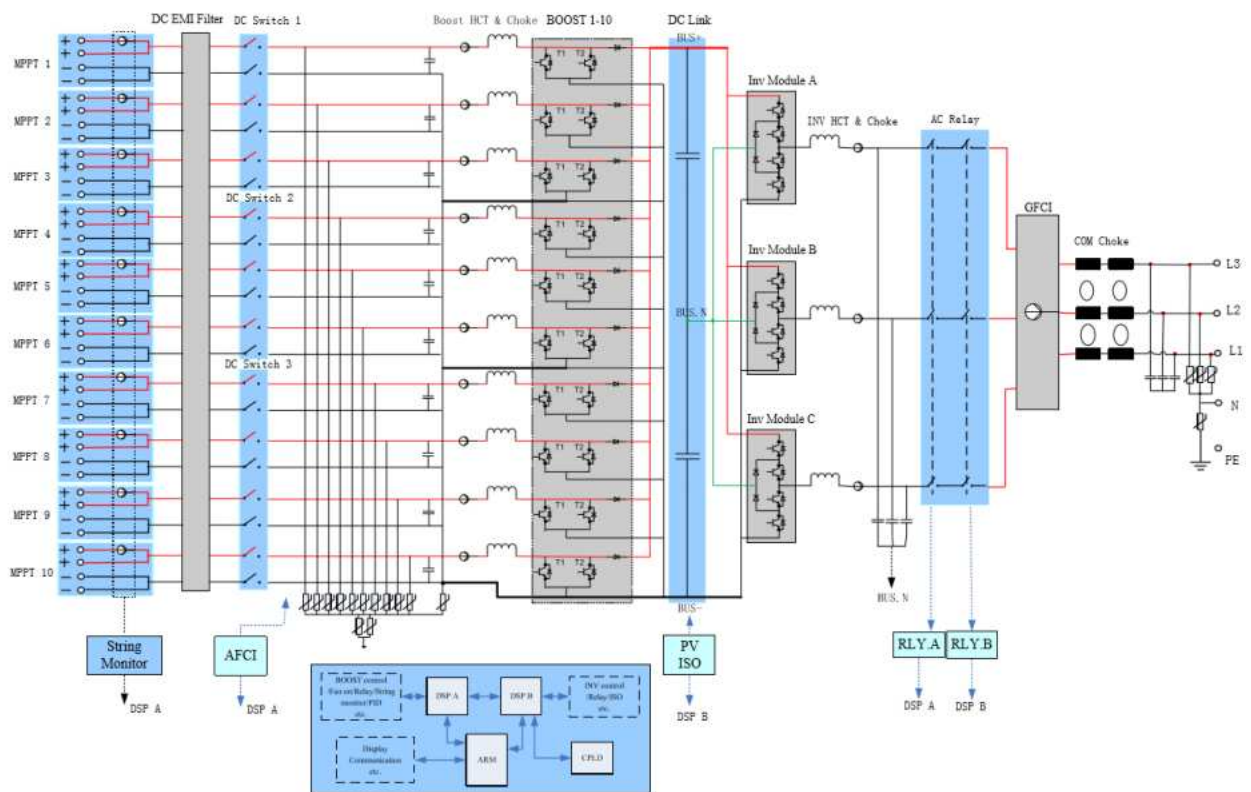

**Difference of models:**

All models are identical, except the number of MPPT and the output power derating in software.

Other than special notice, the model MAX 75KTL3-XL2 is as the representative test model in this report.

| IEC61727   |  |                      |          |
|------------|--|----------------------|----------|
| Cl.        | Requirement - Test   | Result               | Verdict  |
| <b>4</b>   | <b>UTILITY COMPATIBILITY</b>   |                      | <b>P</b> |
|            | The quality of power provided by the PV system for the on-site AC loads and for power delivered to the utility is governed by practices and standards on voltage, flicker, frequency, harmonics and power factor.  |                      | P        |
|            | Deviation from these standards represents out-of-bounds conditions and may require the PV system to sense the deviation and properly disconnect from the utility system.   |                      | P        |
| <b>4.1</b> | <b>Voltage, current and frequency</b>  |                      | <b>P</b> |
|            | The PV system AC voltage, current and frequency are compatible with the utility system.  |                      | P        |
| <b>4.2</b> | <b>Normal voltage operating range</b>  |                      | <b>P</b> |
|            | Utility-interconnected PV systems do not normally regulate voltage, they inject current into the utility. Therefore, the voltage operating range for PV inverters is selected as a protection function that responds to abnormal utility conditions, not as a voltage regulation function. |                      | P        |
| <b>4.3</b> | <b>Flicker</b>   |                      | <b>P</b> |
|            | The operation of the PV system is not cause voltage flicker in excess of limits stated in the relevant sections of IEC 61000-3-3 for systems less than 16 A or IEC 61000-3-5 for systems with current of 16 A and above.   |                      | P        |
| <b>4.4</b> | <b>DC injection</b>  |                      | <b>P</b> |
|            | The PV system is not inject DC current greater than 1 % of the rated inverter output current, into the utility AC interface under any operating condition.   | (See appended table) | P        |
| <b>4.5</b> | <b>Normal frequency operating range</b>  |                      | <b>P</b> |
|            | The PV system operates in synchronism with the utility system, and within the frequency trip limits defined in 5.2.2.  |                      | P        |
| <b>4.6</b> | <b>Harmonics and waveform distortion</b>   |                      | <b>P</b> |
|            | Total harmonic current distortion is less than 5 % at rated inverter output. Each individual harmonic is limited to the percentages listed in Table 1.   | (See appended table) | P        |
|            | Even harmonics in these ranges is less than 25 % of the lower odd harmonic limits listed.  |                      | P        |

| IEC61727                                  |  |  |          |               |                  |   |                 |   |                 |   |                 |   |                 |                |                  |   |                 |   |                 |  |   |
|---|--|--|----------|---------------|------------------|---|-----------------|---|-----------------|---|-----------------|---|-----------------|----------------|------------------|---|-----------------|---|-----------------|--|---|
| Cl.                                       | Requirement - Test   | Result   | Verdict  |               |                  |   |                 |   |                 |   |                 |   |                 |                |                  |   |                 |   |                 |  |   |
|   | <table border="1"> <thead> <tr> <th colspan="2">Table 1 – Current distortion limits</th> </tr> <tr> <th>Odd harmonics</th> <th>Distortion limit</th> </tr> </thead> <tbody> <tr> <td>3<sup>rd</sup> through 9<sup>th</sup></td> <td>Less than 4,0 %</td> </tr> <tr> <td>11<sup>th</sup> through 15<sup>th</sup></td> <td>Less than 2,0 %</td> </tr> <tr> <td>17<sup>th</sup> through 21<sup>st</sup></td> <td>Less than 1,5 %</td> </tr> <tr> <td>23<sup>rd</sup> through 33<sup>rd</sup></td> <td>Less than 0,6 %</td> </tr> <tr> <th>Even harmonics</th> <th>Distortion limit</th> </tr> <tr> <td>2<sup>nd</sup> through 8<sup>th</sup></td> <td>Less than 1,0 %</td> </tr> <tr> <td>10<sup>th</sup> through 32<sup>nd</sup></td> <td>Less than 0,5 %</td> </tr> </tbody> </table> | Table 1 – Current distortion limits                            |          | Odd harmonics | Distortion limit | 3 <sup>rd</sup> through 9 <sup>th</sup> | Less than 4,0 % | 11 <sup>th</sup> through 15 <sup>th</sup> | Less than 2,0 % | 17 <sup>th</sup> through 21 <sup>st</sup> | Less than 1,5 % | 23 <sup>rd</sup> through 33 <sup>rd</sup> | Less than 0,6 % | Even harmonics | Distortion limit | 2 <sup>nd</sup> through 8 <sup>th</sup> | Less than 1,0 % | 10 <sup>th</sup> through 32 <sup>nd</sup> | Less than 0,5 % |  | P |
| Table 1 – Current distortion limits       |  |  |          |               |                  |   |                 |   |                 |   |                 |   |                 |                |                  |   |                 |   |                 |  |   |
| Odd harmonics                             | Distortion limit   |  |          |               |                  |   |                 |   |                 |   |                 |   |                 |                |                  |   |                 |   |                 |  |   |
| 3 <sup>rd</sup> through 9 <sup>th</sup>   | Less than 4,0 %  |  |          |               |                  |   |                 |   |                 |   |                 |   |                 |                |                  |   |                 |   |                 |  |   |
| 11 <sup>th</sup> through 15 <sup>th</sup> | Less than 2,0 %  |  |          |               |                  |   |                 |   |                 |   |                 |   |                 |                |                  |   |                 |   |                 |  |   |
| 17 <sup>th</sup> through 21 <sup>st</sup> | Less than 1,5 %  |  |          |               |                  |   |                 |   |                 |   |                 |   |                 |                |                  |   |                 |   |                 |  |   |
| 23 <sup>rd</sup> through 33 <sup>rd</sup> | Less than 0,6 %  |  |          |               |                  |   |                 |   |                 |   |                 |   |                 |                |                  |   |                 |   |                 |  |   |
| Even harmonics                            | Distortion limit   |  |          |               |                  |   |                 |   |                 |   |                 |   |                 |                |                  |   |                 |   |                 |  |   |
| 2 <sup>nd</sup> through 8 <sup>th</sup>   | Less than 1,0 %  |  |          |               |                  |   |                 |   |                 |   |                 |   |                 |                |                  |   |                 |   |                 |  |   |
| 10 <sup>th</sup> through 32 <sup>nd</sup> | Less than 0,5 %  |  |          |               |                  |   |                 |   |                 |   |                 |   |                 |                |                  |   |                 |   |                 |  |   |
| 4.7                                       | The PV system has a lagging power factor greater than 0,9 when the output is greater than 50 % of the rated inverter output power.   |  | P        |               |                  |   |                 |   |                 |   |                 |   |                 |                |                  |   |                 |   |                 |  |   |
| <b>5</b>                                  | <b>PERSONNEL SAFETY AND EQUIPMENT PROTECTION</b>   |  | <b>P</b> |               |                  |   |                 |   |                 |   |                 |   |                 |                |                  |   |                 |   |                 |  |   |
|   | This Clause provides information and considerations for the safe and proper operation of the utility-connected PV systems.   |  | P        |               |                  |   |                 |   |                 |   |                 |   |                 |                |                  |   |                 |   |                 |  |   |
| <b>5.1</b>                                | <b>Loss of utility voltage</b>   |  | <b>P</b> |               |                  |   |                 |   |                 |   |                 |   |                 |                |                  |   |                 |   |                 |  |   |
|   | To prevent islanding, a utility connected PV system ceases to energize the utility system from a de-energized distribution line irrespective of connected loads or other generators within specified time limits.  | Complied with IEC 62116, See the separate report for reference | P        |               |                  |   |                 |   |                 |   |                 |   |                 |                |                  |   |                 |   |                 |  |   |
|   | A utility distribution line can become de-energized for several reasons. For example, a substation breaker opening due to fault conditions or the distribution line switched out during maintenance.   |  | P        |               |                  |   |                 |   |                 |   |                 |   |                 |                |                  |   |                 |   |                 |  |   |
| <b>5.2</b>                                | <b>Over/under voltage and frequency</b>  |  | <b>P</b> |               |                  |   |                 |   |                 |   |                 |   |                 |                |                  |   |                 |   |                 |  |   |
|   | The abnormal utility conditions of concern are voltage and frequency excursions above or below the values stated in this Clause, and the complete disconnection of the utility, presenting the potential for a distributed resource island.  |  | P        |               |                  |   |                 |   |                 |   |                 |   |                 |                |                  |   |                 |   |                 |  |   |
| <b>5.2.1</b>                              | <b>Over/under voltage</b>  |  | <b>P</b> |               |                  |   |                 |   |                 |   |                 |   |                 |                |                  |   |                 |   |                 |  |   |
|   | When the interface voltage deviates outside the conditions specified in Table 2, the photovoltaic system ceases to energize the utility distribution system. This applies to any phase of a multiphase system.   | (See appended table)   | P        |               |                  |   |                 |   |                 |   |                 |   |                 |                |                  |   |                 |   |                 |  |   |

| IEC61727                                 |  |  |                    |                              |       |                        |       |                            |                      |                       |       |                 |        |  |   |
|--|--|--|--------------------|------------------------------|-------|------------------------|-------|----------------------------|----------------------|-----------------------|-------|-----------------|--------|--|---|
| Cl.                                      | Requirement - Test   | Result                                   | Verdict            |                              |       |                        |       |                            |                      |                       |       |                 |        |  |   |
|  | <p align="center"><b>Table 2 – Response to abnormal voltages</b></p> <table border="1"> <thead> <tr> <th>Voltage (at point of utility connection)</th> <th>Maximum trip time*</th> </tr> </thead> <tbody> <tr> <td><math>V &lt; 0,5 \times V_{nominal}</math></td> <td>0,1 s</td> </tr> <tr> <td><math>50 \% \leq V &lt; 85 \%</math></td> <td>2,0 s</td> </tr> <tr> <td><math>85 \% \leq V \leq 110 \%</math></td> <td>Continuous operation</td> </tr> <tr> <td><math>110 \% &lt; V &lt; 135 \%</math></td> <td>2,0 s</td> </tr> <tr> <td><math>135 \% \leq V</math></td> <td>0,05 s</td> </tr> </tbody> </table> <p>* Trip time refers to the time between the abnormal condition occurring and the inverter ceasing to energize the utility line. The PV system control circuits shall actually remain connected to the utility to allow sensing of utility electrical conditions for use by the "reconnect" feature.</p> | Voltage (at point of utility connection) | Maximum trip time* | $V < 0,5 \times V_{nominal}$ | 0,1 s | $50 \% \leq V < 85 \%$ | 2,0 s | $85 \% \leq V \leq 110 \%$ | Continuous operation | $110 \% < V < 135 \%$ | 2,0 s | $135 \% \leq V$ | 0,05 s |  | P |
| Voltage (at point of utility connection) | Maximum trip time*   |  |                    |                              |       |                        |       |                            |                      |                       |       |                 |        |  |   |
| $V < 0,5 \times V_{nominal}$             | 0,1 s  |  |                    |                              |       |                        |       |                            |                      |                       |       |                 |        |  |   |
| $50 \% \leq V < 85 \%$                   | 2,0 s  |  |                    |                              |       |                        |       |                            |                      |                       |       |                 |        |  |   |
| $85 \% \leq V \leq 110 \%$               | Continuous operation   |  |                    |                              |       |                        |       |                            |                      |                       |       |                 |        |  |   |
| $110 \% < V < 135 \%$                    | 2,0 s  |  |                    |                              |       |                        |       |                            |                      |                       |       |                 |        |  |   |
| $135 \% \leq V$                          | 0,05 s   |  |                    |                              |       |                        |       |                            |                      |                       |       |                 |        |  |   |
| <b>5.2.2</b>                             | <b>Over/under frequency</b>  |  | <b>P</b>           |                              |       |                        |       |                            |                      |                       |       |                 |        |  |   |
|  | When the utility frequency deviates outside the specified conditions the photovoltaic system ceases to energize the utility line. The unit does not have to cease to energize if the frequency returns to the normal utility continuous operation condition within the specified trip time.  | (See appended table)                     | P                  |                              |       |                        |       |                            |                      |                       |       |                 |        |  |   |
|  | When the utility frequency is outside the range of $\pm 1$ Hz, the system ceases to energize the utility line within 0,2 s. The purpose of the allowed range and time delay is to allow continued operation for short-term disturbances and to avoid excessive nuisance tripping in weak-utility system conditions.  |  | P                  |                              |       |                        |       |                            |                      |                       |       |                 |        |  |   |
| <b>5.3</b>                               | <b>Islanding protection</b>  |  | <b>P</b>           |                              |       |                        |       |                            |                      |                       |       |                 |        |  |   |
|  | The PV system must cease to energize the utility line within 2 s of loss of utility.   |  | P                  |                              |       |                        |       |                            |                      |                       |       |                 |        |  |   |
| <b>5.4</b>                               | <b>Response to utility recovery</b>  |  | <b>P</b>           |                              |       |                        |       |                            |                      |                       |       |                 |        |  |   |
|  | Following an out-of-range utility condition that has caused the photovoltaic system to cease energizing, the photovoltaic system is not energize the utility line for 20 s to 5 min after the utility service voltage and frequency have recovered to within the specified ranges.   | (See appended table)                     | P                  |                              |       |                        |       |                            |                      |                       |       |                 |        |  |   |
| <b>5.5</b>                               | <b>Earthing</b>  |  | <b>P</b>           |                              |       |                        |       |                            |                      |                       |       |                 |        |  |   |
|  | The utility interface equipment is earthed/grounded in accordance with IEC 60364-7-712.  |  | P                  |                              |       |                        |       |                            |                      |                       |       |                 |        |  |   |
| <b>5.6</b>                               | <b>Short circuit protection</b>  |  | <b>N/A</b>         |                              |       |                        |       |                            |                      |                       |       |                 |        |  |   |
|  | The photovoltaic system has short-circuit protection in accordance with IEC 60364-7-712.   | Should consider in the end use           | N/A                |                              |       |                        |       |                            |                      |                       |       |                 |        |  |   |
| <b>5.7</b>                               | <b>Isolation and switching</b>   |  | <b>N/A</b>         |                              |       |                        |       |                            |                      |                       |       |                 |        |  |   |
|  | A method of isolation and switching is provided in accordance with IEC 60364-7-712.  | Should consider in the end use           | N/A                |                              |       |                        |       |                            |                      |                       |       |                 |        |  |   |

| IEC61727 |                    |        |         |
|----------|--------------------|--------|---------|
| Cl.      | Requirement - Test | Result | Verdict |

| 4.3                        | TABLE: Flicker |          |           |            | P |
|----------------------------|----------------|----------|-----------|------------|---|
| Model: MAX 75KTL3-XL2      |                |          |           |            |   |
|                            | Starting       | Stopping | Running   |            |   |
| Limit                      | 4%             | 4%       | Pst = 1.0 | Plt = 0.65 |   |
| Test value L1-N            | 1.61           | 2.99     | 0.58      | 0.54       |   |
| Test value L2-N            | 0.73           | 2.86     | 0.59      | 0.55       |   |
| Test value L3-N            | 1.56           | 2.97     | 0.59      | 0.55       |   |
| Supplementary information: |                |          |           |            |   |

| 4.4                        | TABLE: Direct current injection  |  |            |            |           |           |           |                                 | P          |
|----------------------------|----------------------------------|--|------------|------------|-----------|-----------|-----------|---------------------------------|------------|
| Rated output current (A)   | Ratio of rated output power (VA) | Measured DC output current between terminals |            |            |           |           |           | Isolated transformer ? (Yes/No) | Limit (mA) |
|                            |                                  | L1-L2 (mA)                                   | L1-L3 (mA) | L2-L3 (mA) | L1-N (mA) | L2-N (mA) | L3-N (mA) |                                 |            |
| Model: MAX 75KTL3-XL2      |                                  |  |            |            |           |           |           |                                 |            |
| 196.9                      | 25%                              | --   | --         | --         | 215.7     | 109.0     | 120.0     | No                              | 1969       |
| 196.9                      | 50%                              | --   | --         | --         | 152.4     | 129.9     | 109.7     | No                              | 1969       |
| 196.9                      | 100%                             | --   | --         | --         | 582.2     | 565.3     | 517.7     | No                              | 1969       |
| Model: MAX 50KTL3-XL2      |                                  |  |            |            |           |           |           |                                 |            |
| 131.2                      | 25%                              | --   | --         | --         | 486.6     | 543.9     | 607.8     | No                              | 1312       |
| 131.2                      | 50%                              | --   | --         | --         | 497.2     | 458.9     | 442.7     | No                              | 1312       |
| 131.2                      | 100%                             | --   | --         | --         | 535.9     | 523.3     | 473.4     | No                              | 1312       |
| Supplementary information: |                                  |  |            |            |           |           |           |                                 |            |

| 4.6                   | TABLE: Harmonics and waveform distortion |                  |                    |                  |                    |                  |                             | P |
|-----------------------|--|------------------|--------------------|------------------|--------------------|------------------|-----------------------------|---|
| Model: MAX 75KTL3-XL2 |  |                  |                    |                  |                    |                  |                             |   |
| Harmonic              | fundamental L1 (A)                       | % of fundamental | fundamental L2 (A) | % of fundamental | fundamental L3 (A) | % of fundamental | Harmonic Current Limits (%) |   |
| 02                    | 0.2266                                   | 0.1150           | 0.3814             | 0.1950           | 0.1367             | 0.0700           | 1.0%                        |   |
| 03                    | 0.1721                                   | 0.0870           | 0.2336             | 0.1190           | 0.0611             | 0.0310           | 4.0%                        |   |

| IEC61727                   |                    |        |        |        |        |        |         |
|----------------------------|--------------------|--------|--------|--------|--------|--------|---------|
| Cl.                        | Requirement - Test |        |        | Result |        |        | Verdict |
| 04                         | 0.0808             | 0.0410 | 0.2005 | 0.1020 | 0.1947 | 0.0990 | 1.0%    |
| 05                         | 3.2068             | 1.6260 | 3.3086 | 1.6870 | 3.1664 | 1.6140 | 4.0%    |
| 06                         | 0.0604             | 0.0310 | 0.1152 | 0.0590 | 0.0354 | 0.0180 | 1.0%    |
| 07                         | 1.4608             | 0.7410 | 1.5422 | 0.7870 | 1.3969 | 0.7120 | 4.0%    |
| 08                         | 0.1153             | 0.0580 | 0.1279 | 0.0650 | 0.0400 | 0.0200 | 1.0%    |
| 09                         | 0.0739             | 0.0370 | 0.0337 | 0.0170 | 0.0909 | 0.0460 | 4.0%    |
| 10                         | 0.1132             | 0.0570 | 0.1368 | 0.0700 | 0.1026 | 0.0520 | 0.5%    |
| 11                         | 0.9060             | 0.4590 | 0.8268 | 0.4220 | 0.7467 | 0.3810 | 2.0%    |
| 12                         | 0.0852             | 0.0430 | 0.0994 | 0.0510 | 0.0952 | 0.0490 | 0.5%    |
| 13                         | 0.8945             | 0.4530 | 0.9354 | 0.4770 | 0.9098 | 0.4640 | 2.0%    |
| 14                         | 0.0512             | 0.0260 | 0.0207 | 0.0110 | 0.0606 | 0.0310 | 0.5%    |
| 15                         | 0.0663             | 0.0340 | 0.1000 | 0.0510 | 0.0634 | 0.0320 | 2.0%    |
| 16                         | 0.1032             | 0.0520 | 0.0936 | 0.0480 | 0.1050 | 0.0540 | 0.5%    |
| 17                         | 0.7812             | 0.3960 | 0.7098 | 0.3620 | 0.6849 | 0.3490 | 1.5%    |
| 18                         | 0.0544             | 0.0280 | 0.0094 | 0.0050 | 0.0707 | 0.0360 | 0.5%    |
| 19                         | 0.2055             | 0.1040 | 0.2316 | 0.1180 | 0.2439 | 0.1240 | 1.5%    |
| 20                         | 0.0586             | 0.0300 | 0.0806 | 0.0410 | 0.0215 | 0.0110 | 0.5%    |
| 21                         | 0.0418             | 0.0210 | 0.0337 | 0.0170 | 0.0346 | 0.0180 | 1.5%    |
| 22                         | 0.0145             | 0.0070 | 0.0337 | 0.0170 | 0.0080 | 0.0040 | 0.5%    |
| 23                         | 0.3791             | 0.1920 | 0.3900 | 0.1990 | 0.3871 | 0.1970 | 0.6%    |
| 24                         | 0.0016             | 0.0010 | 0.0067 | 0.0030 | 0.0073 | 0.0040 | 0.5%    |
| 25                         | 0.0967             | 0.0490 | 0.0858 | 0.0440 | 0.0925 | 0.0470 | 0.6%    |
| 26                         | 0.0475             | 0.0240 | 0.0413 | 0.0210 | 0.0308 | 0.0160 | 0.5%    |
| 27                         | 0.0184             | 0.0090 | 0.0134 | 0.0070 | 0.0085 | 0.0040 | 0.6%    |
| 28                         | 0.0467             | 0.0240 | 0.0219 | 0.0110 | 0.0285 | 0.0150 | 0.5%    |
| 29                         | 0.0642             | 0.0330 | 0.0830 | 0.0420 | 0.0721 | 0.0370 | 0.6%    |
| 30                         | 0.0283             | 0.0140 | 0.0387 | 0.0200 | 0.0091 | 0.0050 | 0.5%    |
| 31                         | 0.1072             | 0.0540 | 0.0982 | 0.0500 | 0.1058 | 0.0540 | 0.6%    |
| 32                         | 0.0075             | 0.0040 | 0.0290 | 0.0150 | 0.0159 | 0.0080 | 0.5%    |
| 33                         | 0.0407             | 0.0210 | 0.0262 | 0.0130 | 0.0203 | 0.0100 | 0.6%    |
| THD                        | 1.967              |        | 2.039  |        | 1.922  |        | 5%      |
| Supplementary information: |                    |        |        |        |        |        |         |

| IEC61727 |                    |        |         |
|----------|--------------------|--------|---------|
| Cl.      | Requirement - Test | Result | Verdict |

| 4.6                   | TABLE: Harmonics and waveform distortion |                  |                    |                  |                    |                  | P                           |
|-----------------------|--|------------------|--------------------|------------------|--------------------|------------------|-----------------------------|
| Model: MAX 50KTL3-XL2 |  |                  |                    |                  |                    |                  |                             |
| Harmonic              | fundamental L1 (A)                       | % of fundamental | fundamental L2 (A) | % of fundamental | fundamental L3 (A) | % of fundamental | Harmonic Current Limits (%) |
| 02                    | 0.1085                                   | 0.0820           | 0.2345             | 0.1790           | 0.1366             | 0.1040           | 1.0%                        |
| 03                    | 0.0724                                   | 0.0550           | 0.1052             | 0.0800           | 0.0461             | 0.0350           | 4.0%                        |
| 04                    | 0.0952                                   | 0.0720           | 0.1341             | 0.1020           | 0.1260             | 0.0960           | 1.0%                        |
| 05                    | 1.4840                                   | 1.1230           | 1.5372             | 1.1700           | 1.4581             | 1.1090           | 4.0%                        |
| 06                    | 0.0435                                   | 0.0330           | 0.0754             | 0.0570           | 0.0588             | 0.0450           | 1.0%                        |
| 07                    | 0.8371                                   | 0.6330           | 0.9378             | 0.7140           | 0.8570             | 0.6520           | 4.0%                        |
| 08                    | 0.0433                                   | 0.0330           | 0.0692             | 0.0530           | 0.0332             | 0.0250           | 1.0%                        |
| 09                    | 0.0361                                   | 0.0270           | 0.0271             | 0.0210           | 0.0675             | 0.0510           | 4.0%                        |
| 10                    | 0.0115                                   | 0.0090           | 0.0566             | 0.0430           | 0.0654             | 0.0500           | 0.5%                        |
| 11                    | 0.5575                                   | 0.4220           | 0.5276             | 0.4020           | 0.4949             | 0.3770           | 2.0%                        |
| 12                    | 0.0673                                   | 0.0510           | 0.0855             | 0.0650           | 0.0683             | 0.0520           | 0.5%                        |
| 13                    | 0.4533                                   | 0.3430           | 0.4605             | 0.3510           | 0.4722             | 0.3590           | 2.0%                        |
| 14                    | 0.0546                                   | 0.0410           | 0.0302             | 0.0230           | 0.0387             | 0.0290           | 0.5%                        |
| 15                    | 0.0280                                   | 0.0210           | 0.0137             | 0.0100           | 0.0343             | 0.0260           | 2.0%                        |
| 16                    | 0.0411                                   | 0.0310           | 0.0446             | 0.0340           | 0.0077             | 0.0060           | 0.5%                        |
| 17                    | 0.6799                                   | 0.5140           | 0.6253             | 0.4760           | 0.6337             | 0.4820           | 1.5%                        |
| 18                    | 0.0280                                   | 0.0210           | 0.0309             | 0.0240           | 0.0342             | 0.0260           | 0.5%                        |
| 19                    | 0.1276                                   | 0.0970           | 0.1231             | 0.0940           | 0.1045             | 0.0800           | 1.5%                        |
| 20                    | 0.0406                                   | 0.0310           | 0.0573             | 0.0440           | 0.0133             | 0.0100           | 0.5%                        |
| 21                    | 0.0252                                   | 0.0190           | 0.0189             | 0.0140           | 0.0069             | 0.0050           | 1.5%                        |
| 22                    | 0.0167                                   | 0.0130           | 0.0219             | 0.0170           | 0.0280             | 0.0210           | 0.5%                        |
| 23                    | 0.2891                                   | 0.2190           | 0.2797             | 0.2130           | 0.2477             | 0.1880           | 0.6%                        |
| 24                    | 0.0251                                   | 0.0190           | 0.0264             | 0.0200           | 0.0378             | 0.0290           | 0.5%                        |
| 25                    | 0.0961                                   | 0.0730           | 0.1082             | 0.0820           | 0.0522             | 0.0400           | 0.6%                        |
| 26                    | 0.0131                                   | 0.0100           | 0.0431             | 0.0330           | 0.0266             | 0.0200           | 0.5%                        |
| 27                    | 0.0304                                   | 0.0230           | 0.0084             | 0.0060           | 0.0198             | 0.0150           | 0.6%                        |
| 28                    | 0.0420                                   | 0.0320           | 0.0503             | 0.0380           | 0.0717             | 0.0550           | 0.5%                        |
| 29                    | 0.0451                                   | 0.0340           | 0.0461             | 0.0350           | 0.0670             | 0.0510           | 0.6%                        |

| IEC61727                   |                    |        |        |        |        |        |         |
|----------------------------|--------------------|--------|--------|--------|--------|--------|---------|
| Cl.                        | Requirement - Test |        |        | Result |        |        | Verdict |
| 30                         | 0.0197             | 0.0150 | 0.0246 | 0.0190 | 0.0189 | 0.0140 | 0.5%    |
| 31                         | 0.0624             | 0.0470 | 0.1120 | 0.0850 | 0.0753 | 0.0570 | 0.6%    |
| 32                         | 0.0039             | 0.0030 | 0.0193 | 0.0150 | 0.0355 | 0.0270 | 0.5%    |
| 33                         | 0.0189             | 0.0140 | 0.0162 | 0.0120 | 0.0378 | 0.0290 | 0.6%    |
| THD                        | 1.530              |        | 1.596  |        | 1.507  |        | 5%      |
| Supplementary information: |                    |        |        |        |        |        |         |

| 4.7  | TABLE: Power factor |                  |           |                  |                  |           |                    | P                  |
|--|---------------------|------------------|-----------|------------------|------------------|-----------|--------------------|--------------------|
| Model: MAX 75KTL3-XL2  |                     |                  |           |                  |                  |           |                    |                    |
| No   | Input               |                  |           | Output           |                  |           |                    | Rated output (V.A) |
|  | Voltage (V d.c.)    | Current (A d.c.) | Power (W) | Voltage (V a.c.) | Current (A a.c.) | Power (W) | Power factor (+/-) |                    |
| 1  | 362.38              | 44.59            | 16155.43  | 126.32           | 40.16            | 15163.87  | 0.9963             | (20±5)%            |
| 2  | 362.15              | 66.08            | 23929.70  | 126.51           | 60.00            | 22707.25  | 0.9972             | (30±5)%            |
| 3  | 361.78              | 87.82            | 31769.51  | 126.70           | 79.81            | 30263.72  | 0.9977             | (40±5)%            |
| 4  | 127.04              | 99.78            | 12650.93  | 126.88           | 99.40            | 37755.57  | 0.9979             | (50±5)%            |
| 5  | 361.15              | 131.34           | 47431.11  | 127.07           | 118.83           | 45212.32  | 0.9981             | (60±5)%            |
| 6  | 360.94              | 153.26           | 55315.67  | 127.26           | 138.35           | 52717.43  | 0.9981             | (70±5)%            |
| 7  | 360.57              | 175.43           | 63254.93  | 127.44           | 157.83           | 60225.20  | 0.9980             | (80±5)%            |
| 8  | 360.26              | 197.81           | 71260.83  | 127.64           | 177.29           | 67762.75  | 0.9982             | (90±5)%            |
| 9  | 360.00              | 220.18           | 79262.55  | 127.84           | 196.57           | 75255.32  | 0.9982             | (100±5)%           |
| Supplementary information:   |                     |                  |           |                  |                  |           |                    |                    |
| Power factor with "+" indicating leading and "-" indicating lagging. |                     |                  |           |                  |                  |           |                    |                    |

| 4.7                   | TABLE: Power factor |                  |           |                  |                  |           |                    | P                  |
|-----------------------|---------------------|------------------|-----------|------------------|------------------|-----------|--------------------|--------------------|
| Model: MAX 50KTL3-XL2 |                     |                  |           |                  |                  |           |                    |                    |
| No                    | Input               |                  |           | Output           |                  |           |                    | Rated output (V.A) |
|                       | Voltage (V d.c.)    | Current (A d.c.) | Power (W) | Voltage (V a.c.) | Current (A a.c.) | Power (W) | Power factor (+/-) |                    |
| 1                     | 362.62              | 29.90            | 10841.99  | 126.19           | 26.54            | 9994.20   | 0.9947             | (20±5)%            |
| 2                     | 362.38              | 44.33            | 16063.72  | 126.33           | 39.93            | 15079.91  | 0.9965             | (30±5)%            |

| IEC61727   |                    |        |          |        |        |          |        |          |
|--|--------------------|--------|----------|--------|--------|----------|--------|----------|
| Cl.  | Requirement - Test |        |          |        |        | Result   |        | Verdict  |
| 3  | 362.19             | 58.82  | 21304.75 | 126.45 | 53.11  | 20088.39 | 0.9970 | (40±5)%  |
| 4  | 361.95             | 73.20  | 26493.21 | 126.58 | 66.31  | 25113.15 | 0.9974 | (50±5)%  |
| 5  | 361.76             | 87.67  | 31715.18 | 126.71 | 79.46  | 30135.95 | 0.9977 | (60±5)%  |
| 6  | 361.62             | 102.15 | 36939.44 | 126.84 | 92.61  | 35160.84 | 0.9978 | (70±5)%  |
| 7  | 361.43             | 116.69 | 42175.56 | 126.97 | 105.70 | 40180.35 | 0.9979 | (80±5)%  |
| 8  | 361.24             | 131.35 | 47446.70 | 126.89 | 119.01 | 45215.89 | 0.9981 | (90±5)%  |
| 9  | 361.01             | 145.54 | 52541.17 | 127.01 | 131.64 | 50063.54 | 0.9982 | (100±5)% |
| Supplementary information:<br>Power factor with “+” indicating leading and “-“ indicating lagging. |                    |        |          |        |        |          |        |          |

| IEC61727 |                    |        |         |
|----------|--------------------|--------|---------|
| Cl.      | Requirement - Test | Result | Verdict |

| 5.2.1 & 5.4  |                   | TABLE: Under-and over-voltage trip settings and reconnection test |                                |                            |                       |                              |                                 | P |
|--|-------------------|---|--------------------------------|----------------------------|-----------------------|------------------------------|---------------------------------|---|
| <b>(1) Under voltage disconnection procedure</b>             |                   |   |                                |                            |                       |                              |                                 |   |
| Rated output voltage (V)                                     | Output power (VA) | Required min. voltage (V)   | Value of PCE trip settings (V) | Ratio of decreased (V / s) | Interval time (s)     | Measured tripped voltage (V) | Measured disconnection time (s) |   |
| 127  | 75K               | 107.95  | 108.0                          | 0.10                       | 4                     | 106.98                       | 1.49                            |   |
| Rated output voltage (V)                                     | Output power (VA) | Required min. voltage (V)   | Value of PCE trip settings (V) | Ratio of decreased (V / s) | Interval time (s)     | Measured tripped voltage (V) | Measured disconnection time (s) |   |
| 127  | 75K               | 63.5  | 63.0                           | 0.10                       | 0.1                   | 63.90                        | 0.063                           |   |
| <b>(2) Under voltage reconnection procedure</b>              |                   |   |                                |                            |                       |                              |                                 |   |
| Ratio of voltage rapidly decreased (V / s)                   |                   |   | Reconnection voltage (V)       |                            | Reconnection time (s) |                              |                                 |   |
| 0.10   |                   |   | >108                           |                            | 81.2                  |                              |                                 |   |
| <b>(3) Over voltage disconnection procedure</b>              |                   |   |                                |                            |                       |                              |                                 |   |
| Rated output voltage (V)                                     | Output power (VA) | Required max. voltage (V)   | Value of PCE trip settings (V) | Ratio of increased (V / s) | Interval time (s)     | Measured tripped voltage (V) | Measured disconnection time (s) |   |
| 127  | 75K               | 139.7   | 140                            | 0.10                       | 4                     | 139.7                        | 1.50                            |   |
| Rated output voltage (V)                                     | Output power (VA) | Required max. voltage (V)   | Value of PCE trip settings (V) | Ratio of increased (V / s) | Interval time (s)     | Measured tripped voltage (V) | Measured disconnection time (s) |   |
| 127  | 75K               | 171.5   | 172                            | 0.10                       | 0.1                   | 172.2                        | 0.032                           |   |
| <b>(4) Over voltage reconnection procedure</b>               |                   |   |                                |                            |                       |                              |                                 |   |
| Ratio of voltage rapidly decreased (V / s)                   |                   |   | Reconnection voltage (V)       |                            | Reconnection time (s) |                              |                                 |   |
| 0.10   |                   |   | <139                           |                            | 80.90                 |                              |                                 |   |
| Supplementary information:<br>Tested on model MAX 75KTL3-XL2 |                   |   |                                |                            |                       |                              |                                 |   |

|          |                    |        |         |
|----------|--------------------|--------|---------|
| IEC61727 |                    |        |         |
| Cl.      | Requirement - Test | Result | Verdict |

| <b>5.2.2 &amp; 5.4</b>                             |                   | <b>TABLE: Over/under frequency trip settings and reconnection test</b> |                                 |                             |                       |                                 |                                 | <b>P</b> |
|--|-------------------|--|---------------------------------|-----------------------------|-----------------------|---------------------------------|---------------------------------|----------|
| <b>(1) Under frequency disconnection procedure</b> |                   |  |                                 |                             |                       |                                 |                                 |          |
| Rated output frequency (Hz)                        | Output power (VA) | Required min. frequency (Hz)   | Value of PCE trip settings (Hz) | Ratio of decreased (Hz / s) | Interval time (s)     | Measured tripped frequency (Hz) | Measured disconnection time (s) |          |
| 60   | 75K               | 59   | 59                              | 0.01                        | 0.3                   | 59.01                           | 0.185                           |          |
| <b>(2) Under frequency reconnection procedure</b>  |                   |  |                                 |                             |                       |                                 |                                 |          |
| Ratio of frequency rapidly decreased (Hz / s)      |                   |  | Reconnection frequency (Hz)     |                             | Reconnection time (s) |                                 |                                 |          |
| 0.01   |                   |  | >59                             |                             | 82.2                  |                                 |                                 |          |
| <b>(3) Over frequency disconnection procedure</b>  |                   |  |                                 |                             |                       |                                 |                                 |          |
| Rated output frequency (Hz)                        | Output power (VA) | Required max. frequency (Hz)   | Value of PCE trip settings (Hz) | Ratio of increased (Hz / s) | Interval time (s)     | Measured tripped frequency (Hz) | Measured disconnection time (s) |          |
| 60   | 75K               | 61   | 61                              | 0.01                        | 0.3                   | 60.96                           | 0.182                           |          |
| <b>(4) Over frequency reconnection procedure</b>   |                   |  |                                 |                             |                       |                                 |                                 |          |
| Ratio of frequency rapidly decreased (Hz / s)      |                   |  | Reconnection frequency (Hz)     |                             | Reconnection time (s) |                                 |                                 |          |
| 0.01   |                   |  | <61                             |                             | 80.8                  |                                 |                                 |          |
| Supplementary information:                         |                   |  |                                 |                             |                       |                                 |                                 |          |
| Tested on model MAX 75KTL3-XL2 with frequency 60Hz |                   |  |                                 |                             |                       |                                 |                                 |          |

|          |                    |        |         |
|----------|--------------------|--------|---------|
| IEC61727 |                    |        |         |
| Cl.      | Requirement - Test | Result | Verdict |

| <b>5.2.2 &amp; 5.4</b>                             |                   | <b>TABLE: Over/under frequency trip settings and reconnection test</b> |                                 |                             |                       |                                 |                                 | <b>P</b> |
|--|-------------------|--|---------------------------------|-----------------------------|-----------------------|---------------------------------|---------------------------------|----------|
| <b>(1) Under frequency disconnection procedure</b> |                   |  |                                 |                             |                       |                                 |                                 |          |
| Rated output frequency (Hz)                        | Output power (VA) | Required min. frequency (Hz)   | Value of PCE trip settings (Hz) | Ratio of decreased (Hz / s) | Interval time (s)     | Measured tripped frequency (Hz) | Measured disconnection time (s) |          |
| 50   | 75K               | 49   | 49                              | 0.01                        | 0.3                   | 49.01                           | 0.176                           |          |
| <b>(2) Under frequency reconnection procedure</b>  |                   |  |                                 |                             |                       |                                 |                                 |          |
| Ratio of frequency rapidly decreased (Hz / s)      |                   |  | Reconnection frequency (Hz)     |                             | Reconnection time (s) |                                 |                                 |          |
| 0.01   |                   |  | >49                             |                             | 79.0                  |                                 |                                 |          |
| <b>(3) Over frequency disconnection procedure</b>  |                   |  |                                 |                             |                       |                                 |                                 |          |
| Rated output frequency (Hz)                        | Output power (VA) | Required max. frequency (Hz)   | Value of PCE trip settings (Hz) | Ratio of increased (Hz / s) | Interval time (s)     | Measured tripped frequency (Hz) | Measured disconnection time (s) |          |
| 50   | 75K               | 51   | 51                              | 0.01                        | 0.3                   | 50.99                           | 0.193                           |          |
| <b>(4) Over frequency reconnection procedure</b>   |                   |  |                                 |                             |                       |                                 |                                 |          |
| Ratio of frequency rapidly decreased (Hz / s)      |                   |  | Reconnection frequency (Hz)     |                             | Reconnection time (s) |                                 |                                 |          |
| 0.01   |                   |  | <51                             |                             | 79.0                  |                                 |                                 |          |
| Supplementary information:                         |                   |  |                                 |                             |                       |                                 |                                 |          |
| Tested on model MAX 75KTL3-XL2 with frequency 50Hz |                   |  |                                 |                             |                       |                                 |                                 |          |

| IEC61727 |                    |        |         |
|----------|--------------------|--------|---------|
| Cl.      | Requirement - Test | Result | Verdict |

| 5.3   | TABLE: tested condition and run-on time |                             |                 |                 |                 |                       |                             |                     | P  |
|---|---|-----------------------------|-----------------|-----------------|-----------------|-----------------------|-----------------------------|---------------------|--|
| Model: Tested on model MAX 75KTL3-XL2 with frequency 50Hz |   |                             |                 |                 |                 |                       |                             |                     |  |
| No.   | P <sub>EUT</sub> (% of EUT rating)      | Reactive load (% of normal) | P <sub>AC</sub> | Q <sub>AC</sub> | Run-on time(ms) | P <sub>EUT</sub> (KW) | Actual Q <sub>f</sub> (Var) | V <sub>DC</sub> (V) | Which load is selected to be adjusted (R or L) |
| Test condition A  |   |                             |                 |                 |                 |                       |                             |                     |  |
| 1   | 100                                     | 100                         | 0               | 0               | 459.5           | 75.11                 | 1.00                        | 800                 | /  |
| 2   | 100                                     | 100                         | -5              | -5              | 332.5           | 75.11                 | 0.98                        | 800                 | /  |
| 3   | 100                                     | 100                         | -5              | 0               | 279.5           | 75.11                 | 0.95                        | 800                 | /  |
| 4   | 100                                     | 100                         | -5              | +5              | 305.0           | 75.11                 | 0.93                        | 800                 | /  |
| 5   | 100                                     | 100                         | 0               | -5              | 401.0           | 75.11                 | 1.03                        | 800                 | /  |
| 6   | 100                                     | 100                         | 0               | +5              | 311.5           | 75.11                 | 0.98                        | 800                 | /  |
| 7   | 100                                     | 100                         | +5              | -5              | 258.5           | 75.11                 | 1.08                        | 800                 | /  |
| 8   | 100                                     | 100                         | +5              | 0               | 279.5           | 75.11                 | 1.06                        | 800                 | /  |
| 9   | 100                                     | 100                         | +5              | +5              | 157.5           | 75.11                 | 1.03                        | 800                 | /  |
| Test condition B  |   |                             |                 |                 |                 |                       |                             |                     |  |
| 10  | 66                                      | 66                          | 0               | 0               | 299.5           | 49.68                 | 1.00                        | 520                 | /  |
| 11  | 66                                      | 66                          | 0               | -5              | 196.0           | 49.68                 | 1.03                        | 520                 | L  |
| 12  | 66                                      | 66                          | 0               | -4              | 292.0           | 49.68                 | 1.02                        | 520                 | L  |
| 13  | 66                                      | 66                          | 0               | -3              | 287.5           | 49.68                 | 1.02                        | 520                 | L  |
| 14  | 66                                      | 66                          | 0               | -2              | 243.5           | 49.68                 | 1.01                        | 520                 | L  |
| 15  | 66                                      | 66                          | 0               | -1              | 242.0           | 49.68                 | 1.01                        | 520                 | L  |
| 16  | 66                                      | 66                          | 0               | 1               | 308.0           | 49.68                 | 0.99                        | 520                 | L  |
| 17  | 66                                      | 66                          | 0               | 2               | 464.0           | 49.68                 | 0.99                        | 520                 | L  |
| 18  | 66                                      | 66                          | 0               | 3               | 415.5           | 49.68                 | 0.98                        | 520                 | L  |
| 19  | 66                                      | 66                          | 0               | 4               | 409.5           | 49.68                 | 0.98                        | 520                 | L  |
| 20  | 66                                      | 66                          | 0               | 5               | 311.5           | 49.68                 | 0.97                        | 520                 | L  |
| Test condition C  |   |                             |                 |                 |                 |                       |                             |                     |  |
| 21  | 33                                      | 33                          | 0               | 0               | 838.0           | 24.81                 | 1.00                        | 309                 | /  |
| 22  | 33                                      | 33                          | 0               | -5              | 529.0           | 24.81                 | 1.03                        | 309                 | L  |
| 23  | 33                                      | 33                          | 0               | -4              | 668.0           | 24.81                 | 1.02                        | 309                 | L  |
| 24  | 33                                      | 33                          | 0               | -3              | 832.0           | 24.81                 | 1.02                        | 309                 | L  |
| 25  | 33                                      | 33                          | 0               | -2              | 652.0           | 24.81                 | 1.01                        | 309                 | L  |
| 26  | 33                                      | 33                          | 0               | -1              | 770.0           | 24.81                 | 1.01                        | 309                 | L  |
| 27  | 33                                      | 33                          | 0               | 1               | 716.0           | 24.81                 | 0.99                        | 309                 | L  |
| 28  | 33                                      | 33                          | 0               | 2               | 600.0           | 24.81                 | 0.99                        | 309                 | L  |
| 29  | 33                                      | 33                          | 0               | 3               | 858.0           | 24.81                 | 0.98                        | 309                 | L  |
| 30  | 33                                      | 33                          | 0               | 4               | 612.0           | 24.81                 | 0.98                        | 309                 | L  |
| 31  | 33                                      | 33                          | 0               | 5               | 460.0           | 24.81                 | 0.97                        | 309                 | L  |

| IEC61727 |                    |        |         |
|----------|--------------------|--------|---------|
| Cl.      | Requirement - Test | Result | Verdict |

Supplementary information:

For test condition A:

If any of the recorded run-on times are longer than the one recorded for the rated balance condition, then the non-shaded parameter combinations also require testing.

For test condition B and C:

If run-on times are still increasing at the 95 % or 105 % points, additional 1 % increments is taken until run-on times begin decreasing.

| IEC61727 |                    |        |         |
|----------|--------------------|--------|---------|
| Cl.      | Requirement - Test | Result | Verdict |

| 5.3   | TABLE: tested condition and run-on time |                             |                 |                 |                 |                       |                             |                     | P  |
|---|---|-----------------------------|-----------------|-----------------|-----------------|-----------------------|-----------------------------|---------------------|--|
| Model: Tested on model MAX 75KTL3-XL2 with frequency 60Hz |   |                             |                 |                 |                 |                       |                             |                     |  |
| No.   | P <sub>EUT</sub> (% of EUT rating)      | Reactive load (% of normal) | P <sub>AC</sub> | Q <sub>AC</sub> | Run-on time(ms) | P <sub>EUT</sub> (KW) | Actual Q <sub>f</sub> (Var) | V <sub>DC</sub> (V) | Which load is selected to be adjusted (R or L) |
| Test condition A  |   |                             |                 |                 |                 |                       |                             |                     |  |
| 1   | 100                                     | 100                         | 0               | 0               | 730.0           | 75.11                 | 1.00                        | 800                 | /  |
| 2   | 100                                     | 100                         | -5              | -5              | 330.0           | 75.11                 | 0.97                        | 800                 | /  |
| 3   | 100                                     | 100                         | -5              | 0               | 484.0           | 75.11                 | 0.95                        | 800                 | /  |
| 4   | 100                                     | 100                         | -5              | +5              | 414.0           | 75.11                 | 0.93                        | 800                 | /  |
| 5   | 100                                     | 100                         | 0               | -5              | 322.0           | 75.11                 | 1.03                        | 800                 | /  |
| 6   | 100                                     | 100                         | 0               | +5              | 256.0           | 75.11                 | 0.98                        | 800                 | /  |
| 7   | 100                                     | 100                         | +5              | -5              | 260.0           | 75.11                 | 1.08                        | 800                 | /  |
| 8   | 100                                     | 100                         | +5              | 0               | 648.0           | 75.11                 | 1.06                        | 800                 | /  |
| 9   | 100                                     | 100                         | +5              | +5              | 588.0           | 75.11                 | 1.04                        | 800                 | /  |
| Test condition B  |   |                             |                 |                 |                 |                       |                             |                     |  |
| 10  | 66                                      | 66                          | 0               | 0               | 335.5           | 49.68                 | 1.00                        | 520                 | /  |
| 11  | 66                                      | 66                          | 0               | -5              | 259.0           | 49.68                 | 1.03                        | 520                 | L  |
| 12  | 66                                      | 66                          | 0               | -4              | 327.0           | 49.68                 | 1.02                        | 520                 | L  |
| 13  | 66                                      | 66                          | 0               | -3              | 373.5           | 49.68                 | 1.02                        | 520                 | L  |
| 14  | 66                                      | 66                          | 0               | -2              | 327.5           | 49.68                 | 1.01                        | 520                 | L  |
| 15  | 66                                      | 66                          | 0               | -1              | 285.5           | 49.68                 | 1.01                        | 520                 | L  |
| 16  | 66                                      | 66                          | 0               | 1               | 313.0           | 49.68                 | 0.99                        | 520                 | L  |
| 17  | 66                                      | 66                          | 0               | 2               | 629.0           | 49.68                 | 0.99                        | 520                 | L  |
| 18  | 66                                      | 66                          | 0               | 3               | 327.0           | 49.68                 | 0.98                        | 520                 | L  |
| 19  | 66                                      | 66                          | 0               | 4               | 411.0           | 49.68                 | 0.98                        | 520                 | L  |
| 20  | 66                                      | 66                          | 0               | 5               | 299.0           | 49.68                 | 0.97                        | 520                 | L  |
| Test condition C  |   |                             |                 |                 |                 |                       |                             |                     |  |
| 21  | 33                                      | 33                          | 0               | 0               | 530.0           | 24.81                 | 1.00                        | 309                 | /  |
| 22  | 33                                      | 33                          | 0               | -5              | 134.5           | 24.81                 | 1.03                        | 309                 | L  |
| 23  | 33                                      | 33                          | 0               | -4              | 192.5           | 24.81                 | 1.02                        | 309                 | L  |
| 24  | 33                                      | 33                          | 0               | -3              | 178.5           | 24.81                 | 1.02                        | 309                 | L  |
| 25  | 33                                      | 33                          | 0               | -2              | 226.5           | 24.81                 | 1.01                        | 309                 | L  |
| 26  | 33                                      | 33                          | 0               | -1              | 234.5           | 24.81                 | 1.01                        | 309                 | L  |
| 27  | 33                                      | 33                          | 0               | 1               | 235.5           | 24.81                 | 0.99                        | 309                 | L  |
| 28  | 33                                      | 33                          | 0               | 2               | 153.5           | 24.81                 | 0.99                        | 309                 | L  |
| 29  | 33                                      | 33                          | 0               | 3               | 182.5           | 24.81                 | 0.98                        | 309                 | L  |
| 30  | 33                                      | 33                          | 0               | 4               | 176.5           | 24.81                 | 0.98                        | 309                 | L  |
| 31  | 33                                      | 33                          | 0               | 5               | 175.5           | 24.81                 | 0.97                        | 309                 | L  |

| IEC61727 |                    |        |         |
|----------|--------------------|--------|---------|
| Cl.      | Requirement - Test | Result | Verdict |

Supplementary information:  
For test condition A:  
If any of the recorded run-on times are longer than the one recorded for the rated balance condition, then the non-shaded parameter combinations also require testing.  
For test condition B and C:  
If run-on times are still increasing at the 95 % or 105 % points, additional 1 % increments is taken until run-on times begin decreasing.

**Appendix 1: Photos**



Top view of the unit

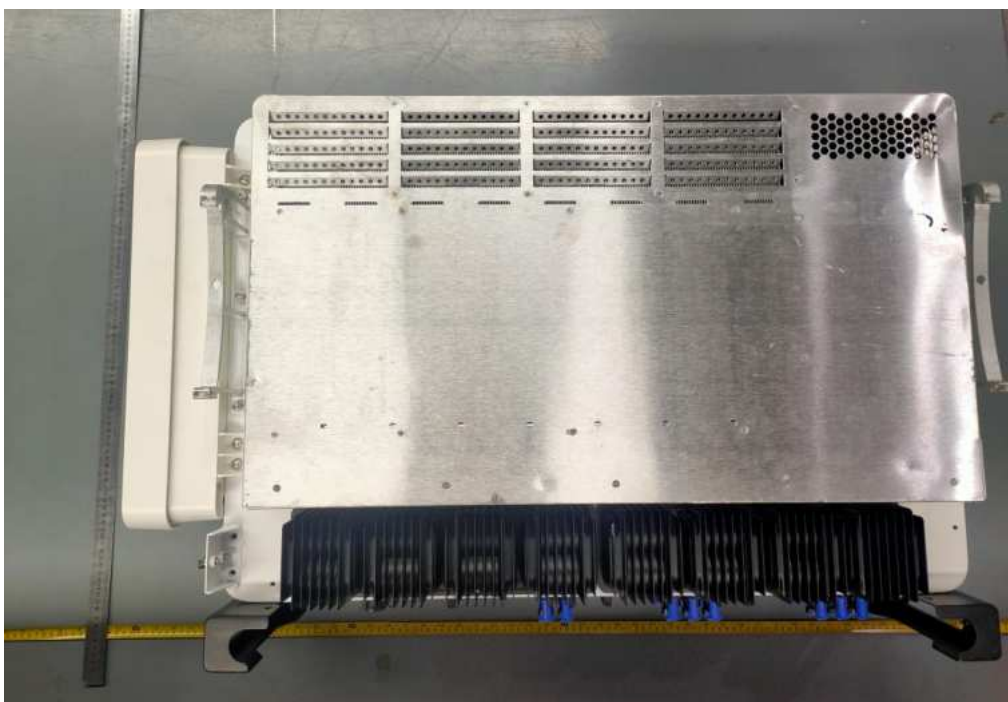

Back view of the unit

**Appendix 1: Photos**



PV Input Terminal view



Side view

**Appendix 1: Photos**

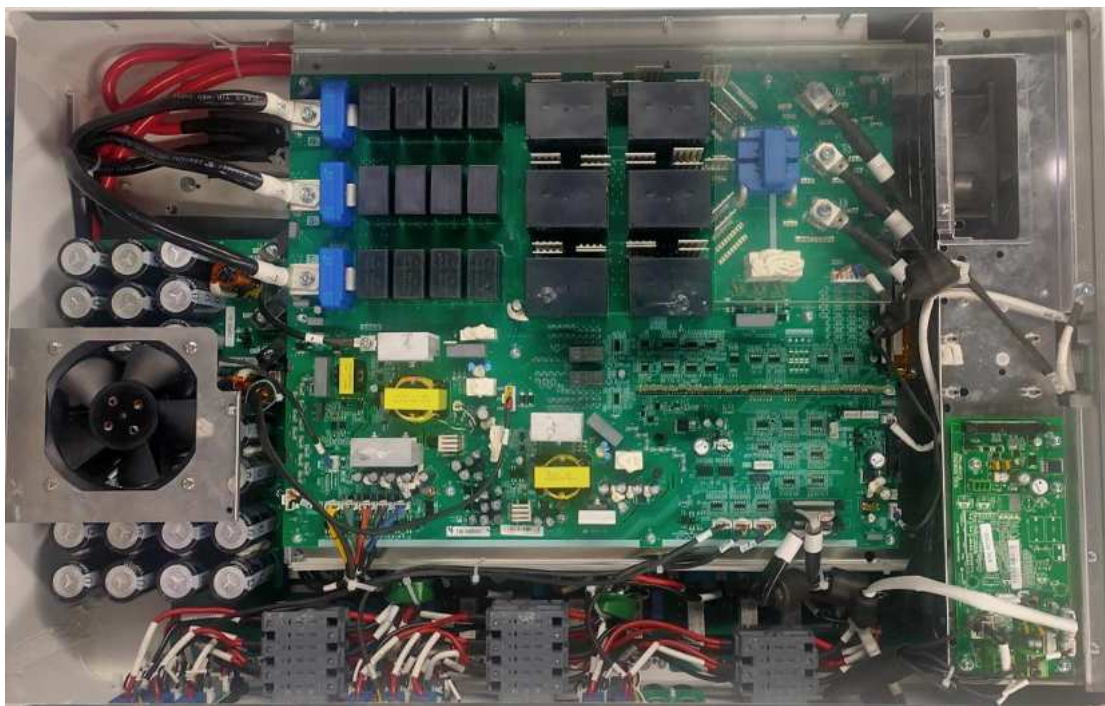

Internal view

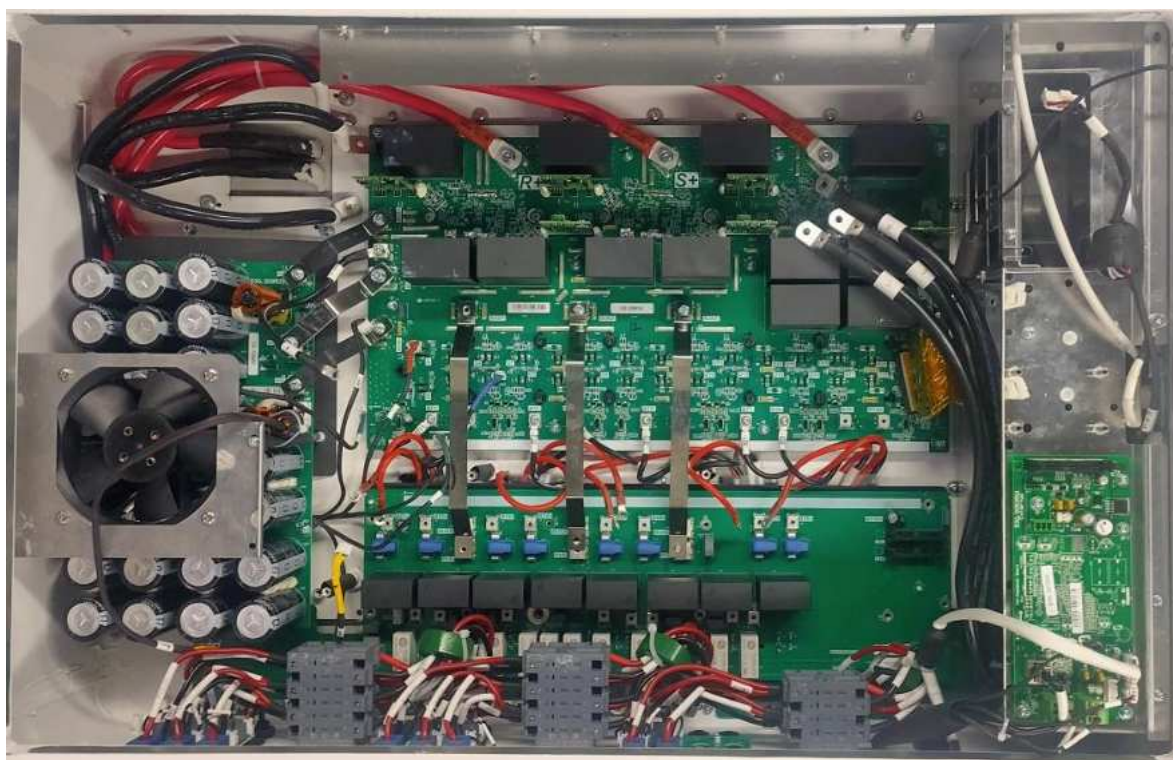

Internal view

--- End of test report---



TL-395

Test Report issued under the responsibility of:



Total Quality. Assured.

|  |   |
|--|---|
| <b>TEST REPORT<br/>IEC 62116<br/>Test procedure of islanding prevention measures for utility-interconnected photovoltaic inverters</b>   |   |
| <b>Report Number</b> .....   | 220308046GZU-002  |
| <b>Date of issue</b> .....   | 30 May 2022   |
| <b>Total number of pages</b> .....   | 18 Pages  |
| <b>Name of Testing Laboratory preparing the Report</b> .....   | Intertek Testing Services Shenzhen Ltd. Guangzhou Branch<br>Room 02, & 101/E201/E301/E401/E501/E601/E701/E801 of Room 01 1-8/F., No. 7-2. Caipin Road, Science City, GETDD, Guangzhou, Guangdong, China |
| <b>Applicant's name</b> .....  | Shenzhen Growatt New Energy Co., Ltd.   |
| <b>Address</b> .....   | 4-13/F, Building A, Sino-German (Europe) Industrial Park, Hangcheng Ave, Bao'an District, Shenzhen, China   |
| <b>Test specification:</b>   |   |
| <b>Standard</b> .....  | IEC 62116:2014  |
| <b>Test procedure</b> .....  | Type approval   |
| <b>Non-standard test method</b> .....  | N/A   |
| <b>Test Report Form No.</b> .....  | IEC62116B   |
| <b>Test Report Form(s) Originator</b> .....  | TÜV SÜD Product Service GmbH  |
| <b>Master TRF</b> .....  | Dated 2017-11-03  |
| <b>Copyright © 2017 IEC System of Conformity Assessment Schemes for Electrotechnical Equipment and Components (IECEE System). All rights reserved.</b>   |   |
| This publication may be reproduced in whole or in part for non-commercial purposes as long as the IECEE is acknowledged as copyright owner and source of the material. IECEE takes no responsibility for and will not assume liability for damages resulting from the reader's interpretation of the reproduced material due to its placement and context. |   |
| If this Test Report Form is used by non-IECEE members, the IECEE/IEC logo and the reference to the CB Scheme procedure shall be removed.   |   |
| <b>This report is not valid as a CB Test Report unless signed by an approved CB Testing Laboratory and appended to a CB Test Certificate issued by an NCB in accordance with IECEE 02.</b>   |   |
| <b>General disclaimer:</b>   |   |
| The test results presented in this report relate only to the object tested.<br>This report shall not be reproduced, except in full, without the written approval of the Issuing CB Testing Laboratory. The authenticity of this Test Report and its contents can be verified by contacting the NCB, responsible for this Test Report.                      |   |

|                                |   |                       |                       |                       |                       |                       |
|--------------------------------|---|-----------------------|-----------------------|-----------------------|-----------------------|-----------------------|
| <b>Test item description :</b> | PV Grid inverter  |                       |                       |                       |                       |                       |
| <b>Trade Mark .....</b>        | GROWATT   |                       |                       |                       |                       |                       |
| <b>Manufacturer .....</b>      | Same as applicant   |                       |                       |                       |                       |                       |
| <b>Model/Type reference :</b>  | MAX 50KTL3-XL2, MAX 60KTL3-XL2, MAX 70KTL3-XL2, MAX 73KTL3-XL2<br>MAX 75KTL3-XL2, MAX 50KTL3-XL1, MAX 60KTL3-XL1, MAX 70KTL3-XL1,<br>MAX 73KTL3-XL1, MAX 75KTL3-XL1 |                       |                       |                       |                       |                       |
| <b>Ratings .....</b>           | Model   | MAX<br>50KTL3-<br>XL2 | MAX<br>60KTL3-<br>XL2 | MAX<br>70KTL3-<br>XL2 | MAX<br>73KTL3-<br>XL2 | MAX<br>75KTL3-<br>XL2 |
|                                | Max.PV<br>voltage   | 1100Vdc               |                       |                       |                       |                       |
|                                | MPPT<br>voltage   | 180-850Vdc            |                       |                       |                       |                       |
|                                | Max.input<br>current  | 8*45A                 |                       |                       |                       |                       |
|                                | PV Isc  | 8*56.5A               |                       |                       |                       |                       |
|                                | Nominal<br>output<br>voltage  | 3W/N/PE, 127/220Vac   |                       |                       |                       |                       |
|                                | Nominal<br>output<br>Frequency  | 50/60Hz               |                       |                       |                       |                       |
|                                | Max.output<br>current   | 144.3A                | 173.2A                | 183.7A                | 191.6A                | 196.9A                |
|                                | Max. output<br>power  | 50KW                  | 60KW                  | 70KW                  | 73KW                  | 75KW                  |
|                                | Max.<br>apparent<br>power   | 55KVA                 | 66KVA                 | 70KVA                 | 73KVA                 | 75KVA                 |
|                                | Power factor<br>range   | 0.8Leading~0.8Lagging |                       |                       |                       |                       |
|                                | Safety level  | Class I               |                       |                       |                       |                       |
|                                | Ingress<br>Protection   | IP 66                 |                       |                       |                       |                       |
|                                | Operation<br>Ambient<br>Temperature   | -30°C - +60°C         |                       |                       |                       |                       |
|                                | Software<br>version   | TN1.0                 |                       |                       |                       |                       |

| Model                         | MAX<br>50KTL3-<br>XL1 | MAX<br>60KTL3-<br>XL1 | MAX<br>70KTL3-<br>XL1 | MAX<br>73KTL3-<br>XL1 | MAX<br>75KTL3-<br>XL1 |
|-------------------------------|-----------------------|-----------------------|-----------------------|-----------------------|-----------------------|
| Max.PV voltage                | 1100Vdc               |                       |                       |                       |                       |
| MPPT voltage                  | 180-850Vdc            |                       |                       |                       |                       |
| Max.input current             | 10*32A                |                       |                       |                       |                       |
| PV Isc                        | 10*40A                |                       |                       |                       |                       |
| Nominal output voltage        | 3W/N/PE, 127/220Vac   |                       |                       |                       |                       |
| Nominal output Frequency      | 50/60Hz               |                       |                       |                       |                       |
| Max.output current            | 144.3A                | 173.2A                | 183.7A                | 191.6A                | 196.9A                |
| Max. output power             | 50KW                  | 60KW                  | 70KW                  | 73KW                  | 75KW                  |
| Max. apparent power           | 55KVA                 | 66KVA                 | 70KVA                 | 73KVA                 | 75KVA                 |
| Power factor range            | 0.8Leading~0.8Lagging |                       |                       |                       |                       |
| Safety level                  | Class I               |                       |                       |                       |                       |
| Ingress Protection            | IP 66                 |                       |                       |                       |                       |
| Operation Ambient Temperature | -30°C - +60°C         |                       |                       |                       |                       |
| Software version              | TN1.0                 |                       |                       |                       |                       |

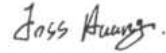
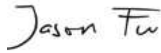
| Responsible Testing Laboratory (as applicable), testing procedure and testing location(s): |  |   |
|--|--|---|
| <input checked="" type="checkbox"/>  | <b>Testing Laboratory:</b>             | Intertek Testing Services Shenzhen Ltd. Guangzhou Branch  |
| <b>Testing location/ address .....</b>   |  | Room 02, & 101/E201/E301/E401/E501/E601/E701/E801 of Room 01 1-8/F., No. 7-2. Caipin Road, Science City, GETDD, Guangzhou, Guangdong, China |
| <b>Tested by (name, function, signature) .....</b>   |  | Joss Huang<br>Engineer<br>                               |
| <b>Approved by (name, function, signature) ..</b>  |  | Jason Fu<br>Supervisor<br>                               |
| <hr/>  |  |   |
| <input type="checkbox"/>   | <b>Testing procedure: CTF Stage 1:</b> | N/A   |
| <b>Testing location/ address .....</b>   |  | N/A   |
| <b>Tested by (name, function, signature) .....</b>   |  | N/A   |
| <b>Approved by (name, function, signature) ..</b>  |  | N/A   |
| <hr/>  |  |   |
| <input type="checkbox"/>   | <b>Testing procedure: CTF Stage 2:</b> | N/A   |
| <b>Testing location/ address .....</b>   |  | N/A   |
| <b>Tested by (name + signature).....</b>   |  | N/A   |
| <b>Witnessed by (name, function, signature) . :</b>  |  | N/A   |
| <b>Approved by (name, function, signature) .. :</b>  |  | N/A   |
| <hr/>  |  |   |
| <input type="checkbox"/>   | <b>Testing procedure: CTF Stage 3:</b> | N/A   |
| <input type="checkbox"/>   | <b>Testing procedure: CTF Stage 4:</b> | N/A   |
| <b>Testing location/ address .....</b>   |  | N/A   |
| <b>Tested by (name, function, signature) .....</b>   |  | N/A   |
| <b>Witnessed by (name, function, signature) . :</b>  |  | N/A   |
| <b>Approved by (name, function, signature) .. :</b>  |  | N/A   |
| <b>Supervised by (name, function, signature) :</b>   |  | N/A   |

|   |   |
|---|---|
| <b>List of Attachments (including a total number of pages in each attachment):</b><br>N/A         |   |
| <b>Summary of testing:</b>  |   |
| <b>Tests performed (name of test and test clause):</b><br>All applicable tests                    | <b>Testing location:</b><br>Intertek Testing Services Shenzhen Ltd.<br>Guangzhou Branch<br>Room 02, &<br>101/E201/E301/E401/E501/E601/E701/E801 of<br>Room 01 1-8/F., No. 7-2. Caipin Road, Science<br>City, GETDD, Guangzhou, Guangdong, China |
| <b>Summary of compliance with National Differences (List of countries addressed):</b><br>N/A      |   |
| <input checked="" type="checkbox"/> <b>The product fulfils the requirements of IEC 62116:2014</b> |   |

**Copy of marking plate:**

The artwork below may be only a draft. The use of certification marks on a product must be authorized by the respective NCBS that own these marks.

| <b>GROWATT</b><br>PV Grid Inverter |                          |
|------------------------------------|--------------------------|
| Model name                         | MAX 75KTL3-XL1           |
| Max. PV voltage                    | 1100 d.c.V               |
| PV voltage range                   | 180-850 d.c.V            |
| PV I <sub>sc</sub>                 | 32 d.c.A*10              |
| Max. input current                 | 40 d.c.A*10              |
| Max. output power                  | 75 kW                    |
| Max. apparent power                | 75 kVA                   |
| Nominal output voltage             | 3W/N/PE<br>127/220 a.c.V |
| Max. output current                | 196.9 a.c.A              |
| Nominal output frequency           | 50/60 Hz                 |
| Power factor range                 | 0.8leading~0.8lagging    |
| Safety level                       | Class I                  |
| Ingress protection                 | IP66                     |
| Operation ambient temperature      | -30°C ~ +60°C            |
| VDE0126-1-1                        |                          |
|                                    |                          |
| Made in China                      |                          |

| <b>GROWATT</b><br>PV Grid Inverter |                          |
|------------------------------------|--------------------------|
| Model name                         | MAX 75KTL3-XL2           |
| Max. PV voltage                    | 1100 d.c.V               |
| PV voltage range                   | 180-850 d.c.V            |
| PV I <sub>sc</sub>                 | 56.5 d.c.A*8             |
| Max. input current                 | 45 d.c.A*8               |
| Max. output power                  | 75 kW                    |
| Max. apparent power                | 75 kVA                   |
| Nominal output voltage             | 3W/N/PE<br>127/220 a.c.V |
| Max. output current                | 196.9 a.c.A              |
| Nominal output frequency           | 50/60 Hz                 |
| Power factor range                 | 0.8leading~0.8lagging    |
| Safety level                       | Class I                  |
| Ingress protection                 | IP66                     |
| Operation ambient temperature      | -30°C ~ +60°C            |
| VDE0126-1-1                        |                          |
|                                    |                          |
| Made in China                      |                          |

**Note:**

1. The above markings are the minimum requirements required by the safety standard. For the final production samples, the additional markings which do not give rise to misunderstanding may be added.
2. Label is attached on the side surface of enclosure and visible after installation.
3. Other labels are identical to above, except the model's name and ratings

|  |  |
|--|--|
| <b>Test item particulars</b> .....:  |  |
| <b>Classification of installation and use</b> .....: Fixed and outdoor use   |  |
| <b>Supply Connection</b> .....: Permanent connection   |  |
| .....:   |  |
| <b>Possible test case verdicts:</b>  |  |
| - <b>test case does not apply to the test object</b> ..... : N/A   |  |
| - <b>test object does meet the requirement</b> ..... : P (Pass)  |  |
| - <b>test object does not meet the requirement</b> ..... : F (Fail)  |  |
| <b>Testing</b> ..... :   |  |
| <b>Date of receipt of test item</b> ..... : 06 April 2022  |  |
| <b>Date (s) of performance of tests</b> ..... : 06 April 2022 to 10 May 2022   |  |
| <b>General remarks:</b>  |  |
| <p>"(See Enclosure #)" refers to additional information appended to the report.<br/>         "(See appended table)" refers to a table appended to the report.<br/> <b>Throughout this report a <input type="checkbox"/> comma / <input checked="" type="checkbox"/> point is used as the decimal separator.</b></p> <p>Determination of the test conclusion is based on IEC Guide 115 in consideration of measurement uncertainty.</p> <p>This report is for the exclusive use of Intertek's Client and is provided pursuant to the agreement between Intertek and its Client. Intertek's responsibility and liability are limited to the terms and conditions of the agreement. Intertek assumes no liability to any party, other than to the Client in accordance with the agreement, for any loss, expense or damage occasioned by the use of this report. Only the Client is authorized to permit copying or distribution of this report and then only in its entirety. Any use of the Intertek name or one of its marks for the sale or advertisement of the tested material, product or service must first be approved in writing by Intertek. The observations and test results in this report are relevant only to the sample tested. This report by itself does not imply that the material, product, or service is or has ever been under an Intertek certification program.</p> <p>The test report only allows to be revised only within the report defined retention period unless standard or regulation was withdrawn or invalid.</p> <p><b>This report shall be used together with the report 220308046GZU-001.</b></p> |  |
| <b>Manufacturer's Declaration per sub-clause 4.2.5 of IEC 62116B:</b>  |  |
| The application for obtaining a CB Test Certificate includes more than one factory location and a declaration from the Manufacturer stating that the sample(s) submitted for evaluation is (are) representative of the products from each factory has been provided ..... :  | <input type="checkbox"/> <b>Yes</b><br><input checked="" type="checkbox"/> <b>Not applicable</b> |

**When differences exist; they shall be identified in the General product information section.**

**Name and address of factory (ies) .....** : Guangdong Growatt New Energy Co., Ltd.  
Growatt Industrial Park, No.17 Pingheng Road  
Pingtan Town, Huiyang District, Huizhou,  
Guangdong, China

**General product information:**

The unit is a three-phase PV Grid inverter, it can convert the high PV voltage to Grid voltage and feed into Grid network.

The unit is providing EMC filtering at the PV side and AC side. It is transformerless between the PV circuit and AC circuit.

The unit has three controllers. The master controller DSP A measure the PV voltage and current, AFCI, PV ISO and also communicate with the slave controller B and slave controller ARM and etc; The slave controller DSP B is used to INV control and PV ISO measurement and etc.

The slave controller ARM monitor AC voltage, GFCI and communicate with the master controller DSP

The relays are designed to redundant structure that controlled by separately.

The master controller A and slave controller B are used together to control relay open or close, if the single fault on one controller, the other controller can be capable to open the relay, so that still providing safety means.

The topology diagram as following:

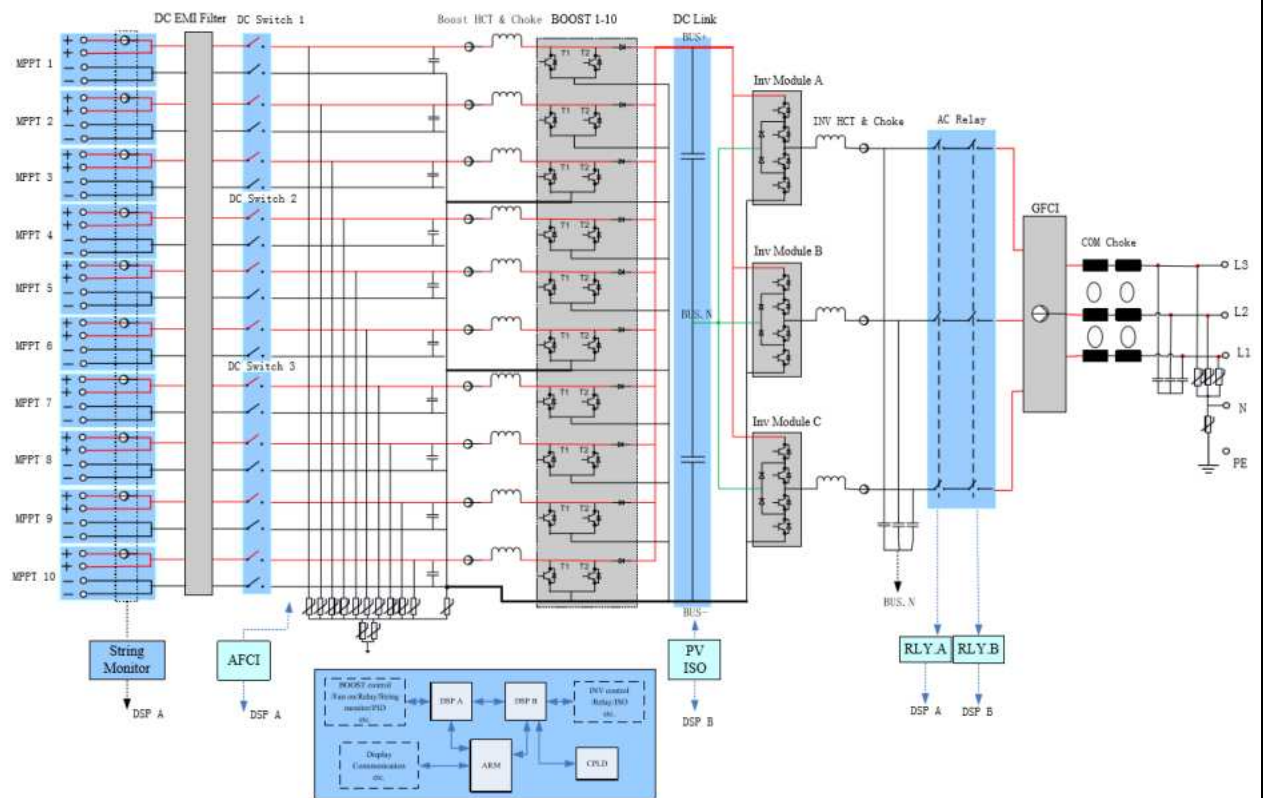

**Difference of models:**

All models are identical, except the number of MPPT and the output power derating in software.

Other than special notice, the model MAX 75KTL3-XL2 is as the representative test model in this report.

| <b>IEC 62116</b> |  |  |         |
|------------------|--|--|---------|
| Clause           | Requirement + Test   | Result - Remark  | Verdict |
| <b>4</b>         | <b>Testing circuit</b>   |  |         |
|                  | The testing circuit shown in Figure 1 is employed.   |  | P       |
|                  | Similar circuits are used for three-phase output.  |  | P       |
|                  | Parameters to be measured are shown in Table 1 and Figure 1. Parameters to be recorded in the test report are discussed in Clause 7.   |  | P       |
| <b>5</b>         | <b>Testing equipment</b>   |  |         |
| <b>5.1</b>       | <b>Measuring instruments</b>   |  |         |
|                  | The waveform measurement/capture device is able to record the waveform from the beginning of the islanding test until the EUT ceases to energize the island.   | Waveform caught from the switch open and the EUT cease to energize | P       |
|                  | For multi-phase EUT, all phases are monitored.   |  | P       |
|                  | A waveform monitor designed to detect and calculate the run-on time may be used.   |  | P       |
|                  | For multi-phase EUT, the test and measurement equipment is recorded each phase current and each phase-to-neutral or phase-to-phase voltage, as appropriate, to determine fundamental frequency active and reactive power flow over the duration of the test.   |  | P       |
|                  | A sampling rate of 10 kHz or higher is recommended. The minimum measurement accuracy is 1 % or less of rated EUT nominal output voltage and 1 % or less of rated EUT output current  |  | P       |
|                  | Current, active power, and reactive power measurements through switch S1 used to determine the circuit balance conditions report the fundamental (50 Hz or 60 Hz) component.   |  | P       |
| <b>5.2</b>       | <b>DC power source</b>   |  |         |
| <b>5.2.1</b>     | <b>General</b>   |  |         |
|                  | A PV array or PV array simulator (preferred) may be used. If the EUT can operate in utility-interconnected mode from a storage battery, a DC power source may be used in lieu of a battery as long as the DC power source is not the limiting device as far as the maximum EUT input current is concerned. | Topcon PV simulator used   | P       |
|                  | The DC power source provides voltage and current necessary to meet the testing requirements described in Clause 6.   |  | P       |
| <b>5.2.2</b>     | <b>PV array simulator</b>  |  |         |
|                  |  |  | P       |

| <b>IEC 62116</b> |  |                          |         |
|------------------|--|--------------------------|---------|
| Clause           | Requirement + Test   | Result - Remark          | Verdict |
|                  | The tests are conducted at the input voltage defined in Table 2 below, and the current is limited to 1,5 times the rated photovoltaic input current, except when specified otherwise by the test requirements.   | Topcon PV simulator used | P       |
|                  | A PV array simulator is recommended, however, any type of power source may be used if it does not influence the test results.  |                          | P       |
| <b>5.2.3</b>     | <b>Current and voltage limited DC power supply with series resistance</b>  |                          | N/A     |
|                  | A DC power source used as the EUT input source is capable of EUT maximum input power (so as to achieve EUT maximum output power) at minimum and maximum EUT input operating voltage.   |                          | N/A     |
|                  | The power source provides adjustable current and voltage limit, set to provide the desired short circuit current and open circuit voltage when combined with the series and shunt resistance described below.  |                          | N/A     |
|                  | A series resistance (and, optionally, a shunt resistance) is selected to provide a fill factor within the range:<br>Output power: Sufficient to provide maximum EUT output power and other levels specified by test conditions of table 5.<br>Response speed: The response time of a simulator to a step in output voltage, due to a 5% load change, results in a settling of the output current to within 10% of its final value in less than 1ms.<br>Stability: Excluding the variations caused by the EUT MPPT, simulator output power remains stable within 2 % of specified power level over the duration of the test: from the point where load balance is achieved until the island condition is cleared or the allowable run-on time is exceeded.<br>Power factor: 0.25 to 0.8 |                          | N/A     |
| <b>5.2.4</b>     | <b>PV array</b>  |                          | N/A     |
|                  | A PV array used as the EUT input source is capable of EUT maximum input power at minimum and maximum EUT input operating voltage.  |                          | N/A     |

| IEC 62116                          |   |                 |            |         |                     |             |         |           |                      |                                    |                   |  |   |
|------------------------------------|---|-----------------|------------|---------|---------------------|-------------|---------|-----------|----------------------|------------------------------------|-------------------|--|---|
| Clause                             | Requirement + Test  | Result - Remark | Verdict    |         |                     |             |         |           |                      |                                    |                   |  |   |
|                                    | Testing is limited to times when the irradiance varies by no more than 2 % over the duration of the test as measured by a silicon-type pyranometer or reference device. It may be necessary to adjust the array configuration to achieve the input voltage and power levels prescribed in 6.1.  |                 | N/A        |         |                     |             |         |           |                      |                                    |                   |  |   |
| <b>5.3</b>                         | <b>AC power source</b>  |                 |            |         |                     |             |         |           |                      |                                    |                   |  |   |
|                                    | <p>The utility grid or other AC power source may be used as long as it meets the conditions specified in Table 4.</p> <p style="text-align: center;"><b>Table 4 – AC power source requirements</b></p> <table border="1" style="width: 100%; border-collapse: collapse;"> <thead> <tr> <th style="text-align: center;">Items</th> <th style="text-align: center;">Conditions</th> </tr> </thead> <tbody> <tr> <td>Voltage</td> <td>Nominal <math>\pm 2.0</math> %</td> </tr> <tr> <td>Voltage THD</td> <td>&lt; 2.5 %</td> </tr> <tr> <td>Frequency</td> <td>Nominal <math>\pm 0.1</math> Hz</td> </tr> <tr> <td>Phase angle distance <sup>1)</sup></td> <td>120 ° <math>\pm</math> 1.5 °</td> </tr> </tbody> </table> <p><small><sup>1)</sup> Three-phase case only.</small></p> | Items           | Conditions | Voltage | Nominal $\pm 2.0$ % | Voltage THD | < 2.5 % | Frequency | Nominal $\pm 0.1$ Hz | Phase angle distance <sup>1)</sup> | 120 ° $\pm$ 1.5 ° |  | P |
| Items                              | Conditions  |                 |            |         |                     |             |         |           |                      |                                    |                   |  |   |
| Voltage                            | Nominal $\pm 2.0$ %   |                 |            |         |                     |             |         |           |                      |                                    |                   |  |   |
| Voltage THD                        | < 2.5 %   |                 |            |         |                     |             |         |           |                      |                                    |                   |  |   |
| Frequency                          | Nominal $\pm 0.1$ Hz  |                 |            |         |                     |             |         |           |                      |                                    |                   |  |   |
| Phase angle distance <sup>1)</sup> | 120 ° $\pm$ 1.5 °   |                 |            |         |                     |             |         |           |                      |                                    |                   |  |   |
| <b>5.4</b>                         | <b>AC loads</b>   |                 |            |         |                     |             |         |           |                      |                                    |                   |  |   |
|                                    | On the AC side of the EUT, variable resistance, capacitance, and inductance are connected in parallel as loads between the EUT and the AC power source. Other sources of load, such as electronic loads, may be used if it can be shown that the source does not cause results that are different than would be obtained with passive resistors, inductors, and capacitors.   |                 | P          |         |                     |             |         |           |                      |                                    |                   |  |   |
|                                    | All AC loads are rated for and adjustable to all test conditions. The equations for Qf are based upon an ideal parallel RLC circuit. For this reason, non-inductive resistors, low loss (high Qf) inductors, and capacitors with low effective series resistance and effective series inductance are utilized in the test circuit. Iron core inductors, if used, are not exceed a current THD of 2 % when operated at nominal voltage. Load components are conservatively rated for the voltage and power levels expected. Resistor power ratings are chosen so as to minimize thermally-induced drift in esistance values during the course of the test.   |                 | P          |         |                     |             |         |           |                      |                                    |                   |  |   |
|                                    | Active and reactive power is calculated (using the measurements provided in Table 1) in each of the R, L and C legs of the load so that these parasitic parameters (and parasitics introduced by variacs or autotransformers) are properly accounted for when calculating Qf.   |                 | P          |         |                     |             |         |           |                      |                                    |                   |  |   |

| IEC 62116 |                    |                 |         |
|-----------|--------------------|-----------------|---------|
| Clause    | Requirement + Test | Result - Remark | Verdict |

|            |   |                             |          |
|------------|---|-----------------------------|----------|
| <b>6</b>   | <b>Test for single or multi-phase inverter</b>  |                             |          |
| <b>6.1</b> | <b>Test procedure</b>   | <b>(see appended table)</b> | <b>P</b> |
|            | The test uses an RLC load, resonant at the EUT nominal frequency (50 Hz or 60 Hz) and matched to the EUT output power.  |                             | P        |
|            | For multi-phase EUT, the load is balanced across all phases and the switch S1 as in Figure 1 opens all phases   |                             | P        |
|            | This test is performed with the EUT conditions as in Table 5, where power and voltage values are given as a percent of EUT full output rating.  |                             | P        |
|            | a) ..Determine EUT test output power  |                             | P        |
|            | b) .Adjusting the DC input source   |                             | P        |
|            | c) .Turn off the EUT and open S1  |                             | P        |
|            | d) .Adjust the RLC circuit to have $Q_f = 1.0 \pm 0.05$   |                             | P        |
|            | e) ..Connect the RLC load configured in step d) to the EUT by closing S2  |                             | P        |
|            | f) ..Open the utility-disconnect switch S1 to initiate the test, Run-on time is recorded.   |                             | P        |
|            | g) .For test condition A, adjust the real load and only one of the reactive load components to each of the load imbalance conditions shown in the shaded portion of table 6. If any of the recorded run-on times are longer than the one recorded for the rated balance condition, then the non-shaded parameter combinations also require testing. |                             | P        |
|            | h) For test condition B and C, adjust the only one reactive load components by approximately 1,0% per test, within a total range of 95% to 105% of the operating point. If run-on times are still increasing at the 95% or 105% points, additional 1% increments have to be taken until run-on times begin decreasing.                              |                             | P        |
| <b>6.2</b> | <b>Pass/fail criteria</b>   |                             |          |
|            | An EUT is considered to comply with the requirements for islanding protection when each case of recorded run-on time is less than 2 s or meets the requirements of local codes.   |                             | P        |
| <b>7</b>   | <b>Documentation</b>  |                             |          |
|            | At a minimum, the following information is recorded and maintained in the test report.  |                             | P        |
|            | a) Specifications of EUT. Table 8 provides an example of the type of information that is provided.  |                             | P        |

| IEC 62116 |  |                 |         |
|-----------|--|-----------------|---------|
| Clause    | Requirement + Test   | Result - Remark | Verdict |
|           | b) Measurement results. Table 9 provides an example of the type of information that is provided. Actual measured values is to be recorded. |                 | P       |
|           | c) Block diagram of test circuit.  |                 | P       |
|           | d) Specifications of the test and measurement equipment. Table 10 provides an example of the type of information that is provided.         |                 | P       |
|           | e) Any test configuration or procedure details such as methods of achieving specified load and EUT output conditions.                      |                 | P       |
|           | f) Any additional information required by the testing laboratory's accreditation.  |                 | P       |
|           | g) Specify the evaluation criterion from clause 6.2 that was utilized to determine if the product passed or failed the test.               |                 | P       |
| Annex A   | Islanding as it applies to PV systems(Informative)   |                 | --      |
| A.1       | General  |                 | --      |
| A.2       | Impact of distortion on islanding  |                 | --      |
| Annex B   | Test for independent islanding detection device (relay)(Informative)   |                 | --      |
| B.1       | Introduction   |                 | --      |
| B.2       | Testing circuit  |                 | --      |
| B.3       | Testing equipment  |                 | --      |
| B.4       | Testing procedure  |                 | --      |
| B.5       | Documentation  |                 | --      |

| IEC 62116 |                    |                 |         |
|-----------|--------------------|-----------------|---------|
| Clause    | Requirement + Test | Result - Remark | Verdict |

| 6   | TABLE: tested condition and run-on time |                             |                 |                 |                 |                       |                             |                     |  | P |
|---|---|-----------------------------|-----------------|-----------------|-----------------|-----------------------|-----------------------------|---------------------|--|---|
| Model: Tested on model MAX 75KTL3-XL2 with frequency 50Hz |   |                             |                 |                 |                 |                       |                             |                     |  |   |
| No.   | P <sub>EUT</sub> (% of EUT rating)      | Reactive load (% of normal) | P <sub>AC</sub> | Q <sub>AC</sub> | Run-on time(ms) | P <sub>EUT</sub> (KW) | Actual Q <sub>f</sub> (Var) | V <sub>DC</sub> (V) | Which load is selected to be adjusted (R or L) |   |
| Test condition A  |   |                             |                 |                 |                 |                       |                             |                     |  |   |
| 1   | 100                                     | 100                         | 0               | 0               | 459.5           | 75.11                 | 1.00                        | 800                 | /  |   |
| 2   | 100                                     | 100                         | -5              | -5              | 332.5           | 75.11                 | 0.98                        | 800                 | /  |   |
| 3   | 100                                     | 100                         | -5              | 0               | 279.5           | 75.11                 | 0.95                        | 800                 | /  |   |
| 4   | 100                                     | 100                         | -5              | +5              | 305.0           | 75.11                 | 0.93                        | 800                 | /  |   |
| 5   | 100                                     | 100                         | 0               | -5              | 401.0           | 75.11                 | 1.03                        | 800                 | /  |   |
| 6   | 100                                     | 100                         | 0               | +5              | 311.5           | 75.11                 | 0.98                        | 800                 | /  |   |
| 7   | 100                                     | 100                         | +5              | -5              | 258.5           | 75.11                 | 1.08                        | 800                 | /  |   |
| 8   | 100                                     | 100                         | +5              | 0               | 279.5           | 75.11                 | 1.06                        | 800                 | /  |   |
| 9   | 100                                     | 100                         | +5              | +5              | 157.5           | 75.11                 | 1.03                        | 800                 | /  |   |
| Test condition B  |   |                             |                 |                 |                 |                       |                             |                     |  |   |
| 10  | 66                                      | 66                          | 0               | 0               | 299.5           | 49.68                 | 1.00                        | 520                 | /  |   |
| 11  | 66                                      | 66                          | 0               | -5              | 196.0           | 49.68                 | 1.03                        | 520                 | L  |   |
| 12  | 66                                      | 66                          | 0               | -4              | 292.0           | 49.68                 | 1.02                        | 520                 | L  |   |
| 13  | 66                                      | 66                          | 0               | -3              | 287.5           | 49.68                 | 1.02                        | 520                 | L  |   |
| 14  | 66                                      | 66                          | 0               | -2              | 243.5           | 49.68                 | 1.01                        | 520                 | L  |   |
| 15  | 66                                      | 66                          | 0               | -1              | 242.0           | 49.68                 | 1.01                        | 520                 | L  |   |
| 16  | 66                                      | 66                          | 0               | 1               | 308.0           | 49.68                 | 0.99                        | 520                 | L  |   |
| 17  | 66                                      | 66                          | 0               | 2               | 464.0           | 49.68                 | 0.99                        | 520                 | L  |   |
| 18  | 66                                      | 66                          | 0               | 3               | 415.5           | 49.68                 | 0.98                        | 520                 | L  |   |
| 19  | 66                                      | 66                          | 0               | 4               | 409.5           | 49.68                 | 0.98                        | 520                 | L  |   |
| 20  | 66                                      | 66                          | 0               | 5               | 311.5           | 49.68                 | 0.97                        | 520                 | L  |   |
| Test condition C  |   |                             |                 |                 |                 |                       |                             |                     |  |   |
| 21  | 33                                      | 33                          | 0               | 0               | 838.0           | 24.81                 | 1.00                        | 309                 | /  |   |
| 22  | 33                                      | 33                          | 0               | -5              | 529.0           | 24.81                 | 1.03                        | 309                 | L  |   |
| 23  | 33                                      | 33                          | 0               | -4              | 668.0           | 24.81                 | 1.02                        | 309                 | L  |   |
| 24  | 33                                      | 33                          | 0               | -3              | 832.0           | 24.81                 | 1.02                        | 309                 | L  |   |
| 25  | 33                                      | 33                          | 0               | -2              | 652.0           | 24.81                 | 1.01                        | 309                 | L  |   |
| 26  | 33                                      | 33                          | 0               | -1              | 770.0           | 24.81                 | 1.01                        | 309                 | L  |   |
| 27  | 33                                      | 33                          | 0               | 1               | 716.0           | 24.81                 | 0.99                        | 309                 | L  |   |
| 28  | 33                                      | 33                          | 0               | 2               | 600.0           | 24.81                 | 0.99                        | 309                 | L  |   |
| 29  | 33                                      | 33                          | 0               | 3               | 858.0           | 24.81                 | 0.98                        | 309                 | L  |   |
| 30  | 33                                      | 33                          | 0               | 4               | 612.0           | 24.81                 | 0.98                        | 309                 | L  |   |
| 31  | 33                                      | 33                          | 0               | 5               | 460.0           | 24.81                 | 0.97                        | 309                 | L  |   |

| IEC 62116 |                    |                 |         |
|-----------|--------------------|-----------------|---------|
| Clause    | Requirement + Test | Result - Remark | Verdict |

Supplementary information:

For test condition A:

If any of the recorded run-on times are longer than the one recorded for the rated balance condition, then the non-shaded parameter combinations also require testing.

For test condition B and C:

If run-on times are still increasing at the 95 % or 105 % points, additional 1 % increments is taken until run-on times begin decreasing.

| IEC 62116 |                    |                 |         |
|-----------|--------------------|-----------------|---------|
| Clause    | Requirement + Test | Result - Remark | Verdict |

| 6   | TABLE: tested condition and run-on time |                             |                 |                 |                 |                       |                             |                     |  | P |
|---|---|-----------------------------|-----------------|-----------------|-----------------|-----------------------|-----------------------------|---------------------|--|---|
| Model: Tested on model MAX 75KTL3-XL2 with frequency 60Hz |   |                             |                 |                 |                 |                       |                             |                     |  |   |
| No.   | P <sub>EUT</sub> (% of EUT rating)      | Reactive load (% of normal) | P <sub>AC</sub> | Q <sub>AC</sub> | Run-on time(ms) | P <sub>EUT</sub> (KW) | Actual Q <sub>f</sub> (Var) | V <sub>DC</sub> (V) | Which load is selected to be adjusted (R or L) |   |
| Test condition A  |   |                             |                 |                 |                 |                       |                             |                     |  |   |
| 1   | 100                                     | 100                         | 0               | 0               | 730.0           | 75.11                 | 1.00                        | 800                 | /  |   |
| 2   | 100                                     | 100                         | -5              | -5              | 330.0           | 75.11                 | 0.97                        | 800                 | /  |   |
| 3   | 100                                     | 100                         | -5              | 0               | 484.0           | 75.11                 | 0.95                        | 800                 | /  |   |
| 4   | 100                                     | 100                         | -5              | +5              | 414.0           | 75.11                 | 0.93                        | 800                 | /  |   |
| 5   | 100                                     | 100                         | 0               | -5              | 322.0           | 75.11                 | 1.03                        | 800                 | /  |   |
| 6   | 100                                     | 100                         | 0               | +5              | 256.0           | 75.11                 | 0.98                        | 800                 | /  |   |
| 7   | 100                                     | 100                         | +5              | -5              | 260.0           | 75.11                 | 1.08                        | 800                 | /  |   |
| 8   | 100                                     | 100                         | +5              | 0               | 648.0           | 75.11                 | 1.06                        | 800                 | /  |   |
| 9   | 100                                     | 100                         | +5              | +5              | 588.0           | 75.11                 | 1.04                        | 800                 | /  |   |
| Test condition B  |   |                             |                 |                 |                 |                       |                             |                     |  |   |
| 10  | 66                                      | 66                          | 0               | 0               | 335.5           | 49.68                 | 1.00                        | 520                 | /  |   |
| 11  | 66                                      | 66                          | 0               | -5              | 259.0           | 49.68                 | 1.03                        | 520                 | L  |   |
| 12  | 66                                      | 66                          | 0               | -4              | 327.0           | 49.68                 | 1.02                        | 520                 | L  |   |
| 13  | 66                                      | 66                          | 0               | -3              | 373.5           | 49.68                 | 1.02                        | 520                 | L  |   |
| 14  | 66                                      | 66                          | 0               | -2              | 327.5           | 49.68                 | 1.01                        | 520                 | L  |   |
| 15  | 66                                      | 66                          | 0               | -1              | 285.5           | 49.68                 | 1.01                        | 520                 | L  |   |
| 16  | 66                                      | 66                          | 0               | 1               | 313.0           | 49.68                 | 0.99                        | 520                 | L  |   |
| 17  | 66                                      | 66                          | 0               | 2               | 629.0           | 49.68                 | 0.99                        | 520                 | L  |   |
| 18  | 66                                      | 66                          | 0               | 3               | 327.0           | 49.68                 | 0.98                        | 520                 | L  |   |
| 19  | 66                                      | 66                          | 0               | 4               | 411.0           | 49.68                 | 0.98                        | 520                 | L  |   |
| 20  | 66                                      | 66                          | 0               | 5               | 299.0           | 49.68                 | 0.97                        | 520                 | L  |   |
| Test condition C  |   |                             |                 |                 |                 |                       |                             |                     |  |   |
| 21  | 33                                      | 33                          | 0               | 0               | 530.0           | 24.81                 | 1.00                        | 309                 | /  |   |
| 22  | 33                                      | 33                          | 0               | -5              | 134.5           | 24.81                 | 1.03                        | 309                 | L  |   |
| 23  | 33                                      | 33                          | 0               | -4              | 192.5           | 24.81                 | 1.02                        | 309                 | L  |   |
| 24  | 33                                      | 33                          | 0               | -3              | 178.5           | 24.81                 | 1.02                        | 309                 | L  |   |
| 25  | 33                                      | 33                          | 0               | -2              | 226.5           | 24.81                 | 1.01                        | 309                 | L  |   |
| 26  | 33                                      | 33                          | 0               | -1              | 234.5           | 24.81                 | 1.01                        | 309                 | L  |   |
| 27  | 33                                      | 33                          | 0               | 1               | 235.5           | 24.81                 | 0.99                        | 309                 | L  |   |
| 28  | 33                                      | 33                          | 0               | 2               | 153.5           | 24.81                 | 0.99                        | 309                 | L  |   |
| 29  | 33                                      | 33                          | 0               | 3               | 182.5           | 24.81                 | 0.98                        | 309                 | L  |   |
| 30  | 33                                      | 33                          | 0               | 4               | 176.5           | 24.81                 | 0.98                        | 309                 | L  |   |
| 31  | 33                                      | 33                          | 0               | 5               | 175.5           | 24.81                 | 0.97                        | 309                 | L  |   |

| IEC 62116 |                    |                 |         |
|-----------|--------------------|-----------------|---------|
| Clause    | Requirement + Test | Result - Remark | Verdict |

Supplementary information:

For test condition A:

If any of the recorded run-on times are longer than the one recorded for the rated balance condition, then the non-shaded parameter combinations also require testing.

For test condition B and C:

If run-on times are still increasing at the 95 % or 105 % points, additional 1 % increments is taken until run-on times begin decreasing.

--- End of test report---